

# STEP ONE

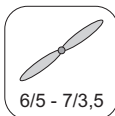
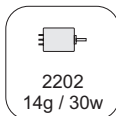
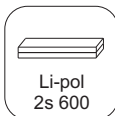
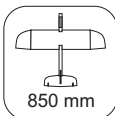

V1.0

## Kit Contents:

- \* fuselage
- \* wings
- \* canopy
- \* horizontal stabilizer
- \* vertical stabilizer
- \* landing gear
- \* accessory pack
- \* spar
- \* carbon pushrods

## Accessory Pack Contents:

- \* carbon diam. 2x150mm ... 1x - landing gear axle
- \* screw M4x20 ... 1x - (wing/fuselage joint)
- \* dural. nut M4 ... 1x (for the wing holding screw)
- \* click-on clevis ... 4x - 2x for the tail controls, 2x spare
- \* heatshrink tube (for the click-on clevises) ... 4x
- \* brass pin clevises ... 2x
- \* bowden end ... 2x
- \* plastic tube 3/2x38mm ... 3x - (for the landing gear)
- \* silikon tubing 2/1x5mm ... 4x - (2x for the landing gear, 2x spare)
- \* plastic arm ... 1x
- \* plywood parts
- \* EPP wheels
- \* balast 5g ... 1x

## Horns etc.:

1. elevator and rudder horns
2. landing gear support
3. wing screw support washer

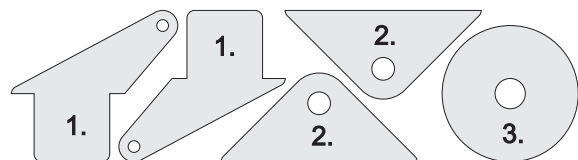

## You may also need:

- \* sharp x-acto knife
- \* philips screwdriver
- \* tweezers
- \* little pliers
- \* CA glue medium + thin, CA kicker
- \* 10cm servo cable extension

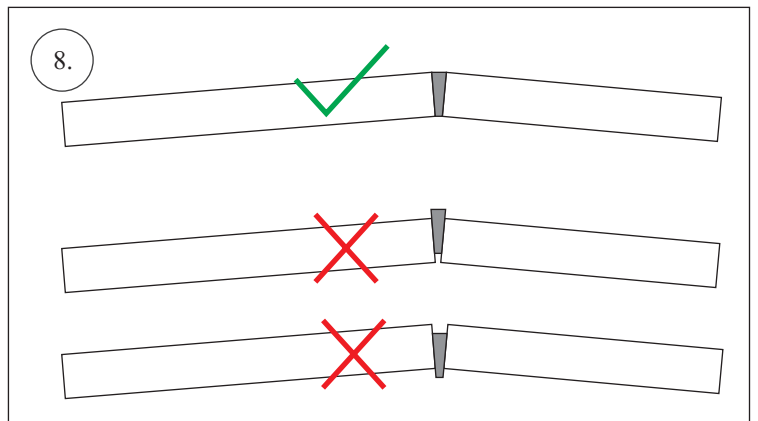
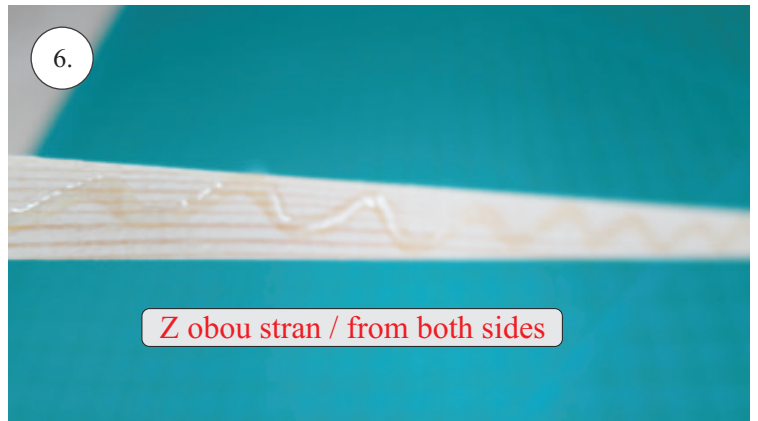
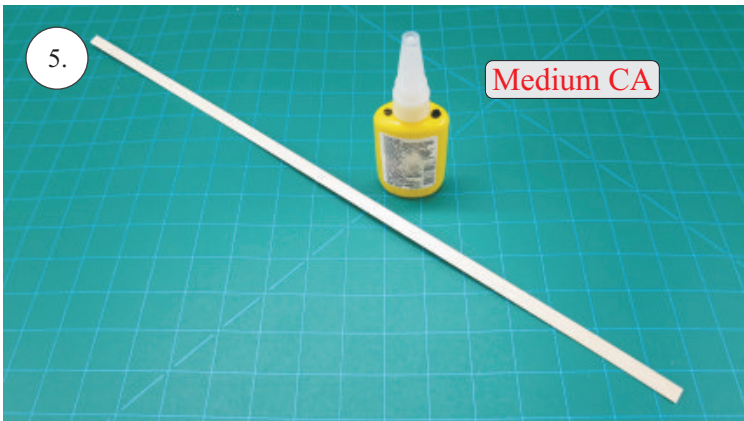
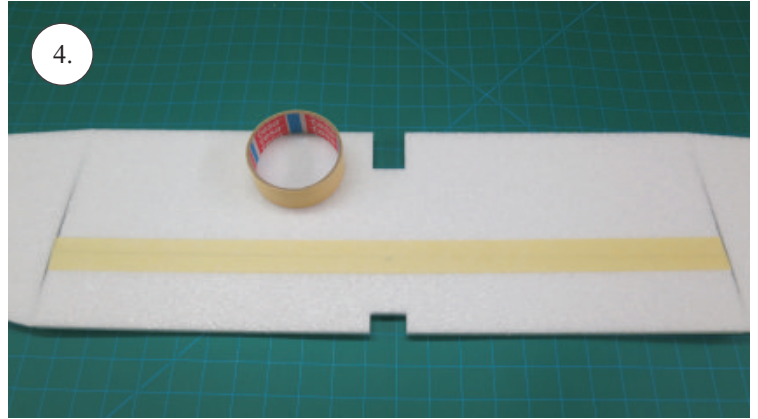
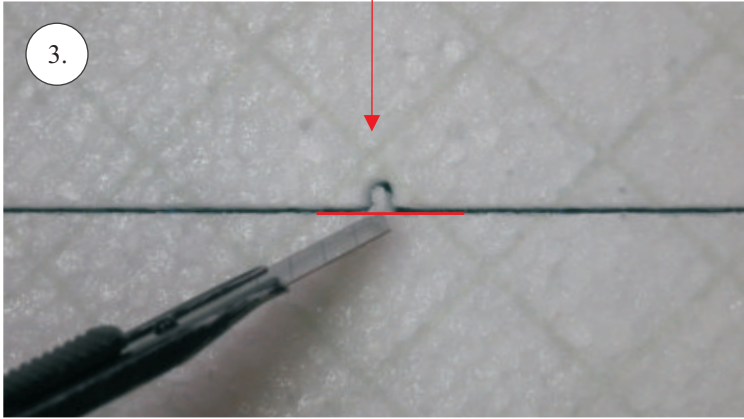
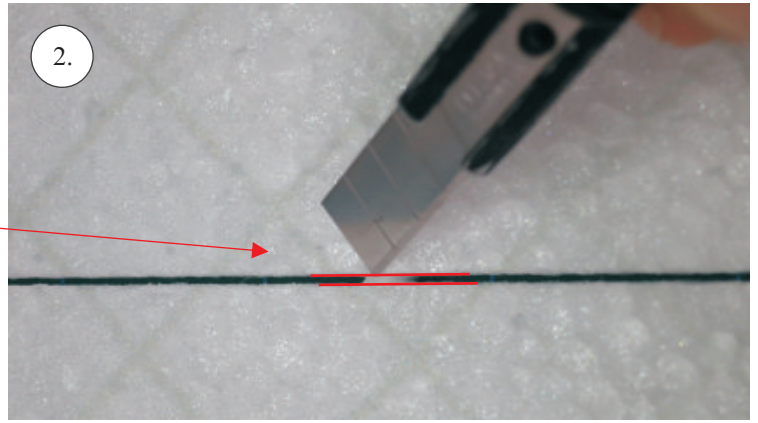
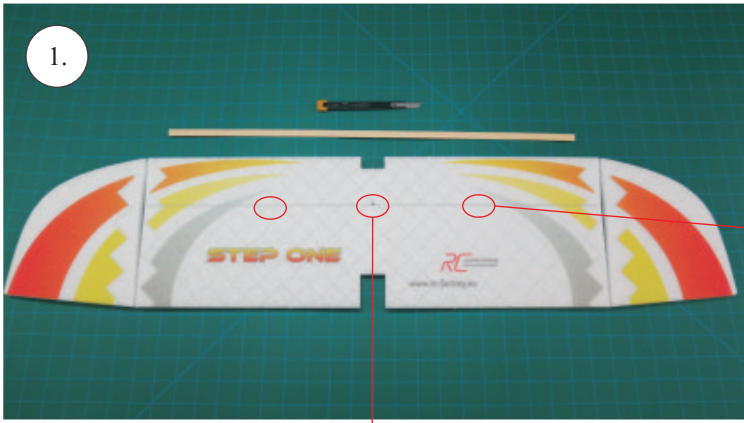

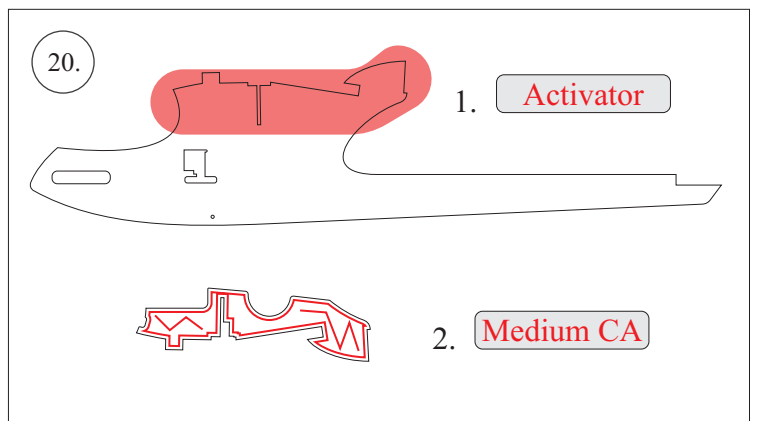
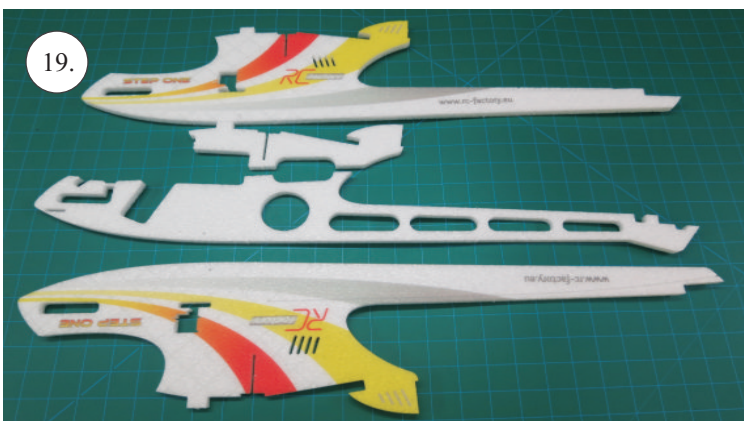
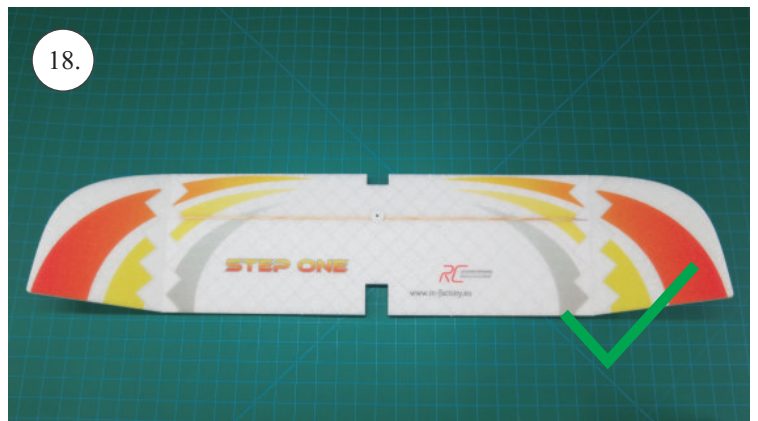
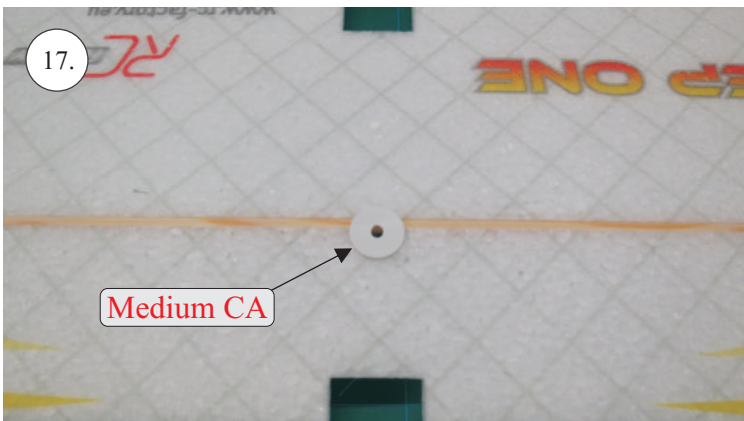
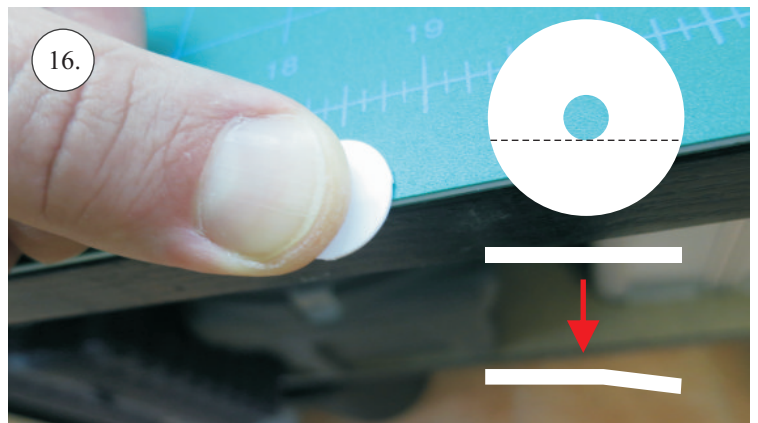
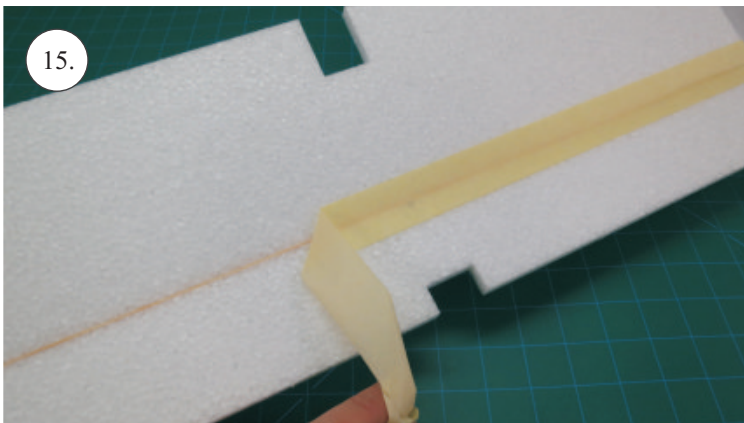
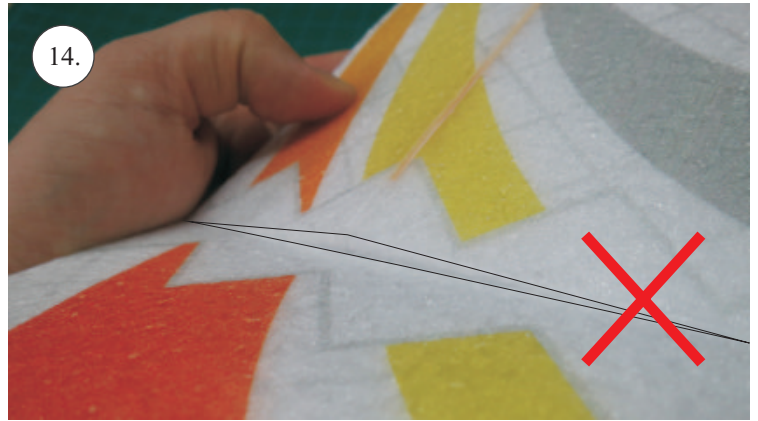
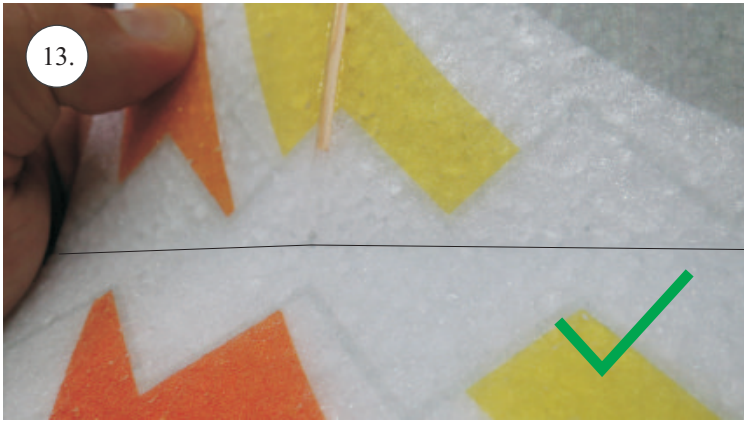
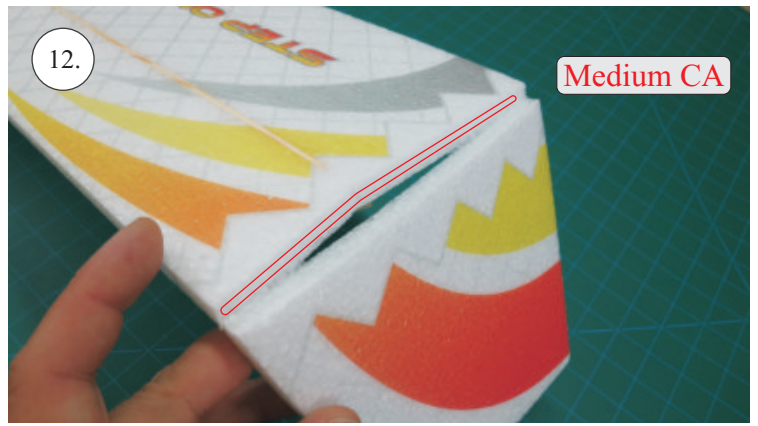

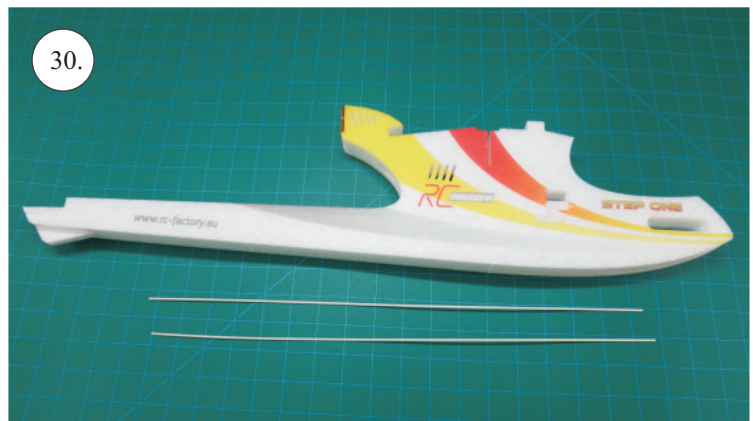
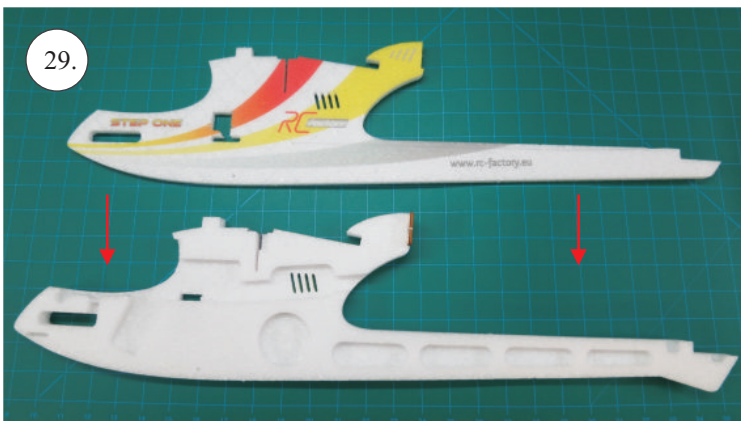
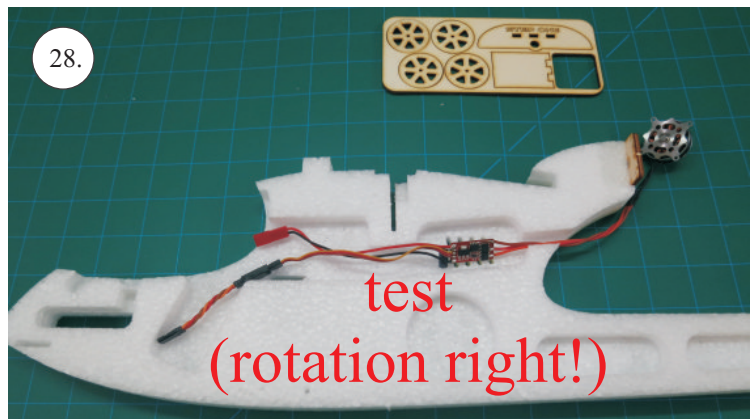
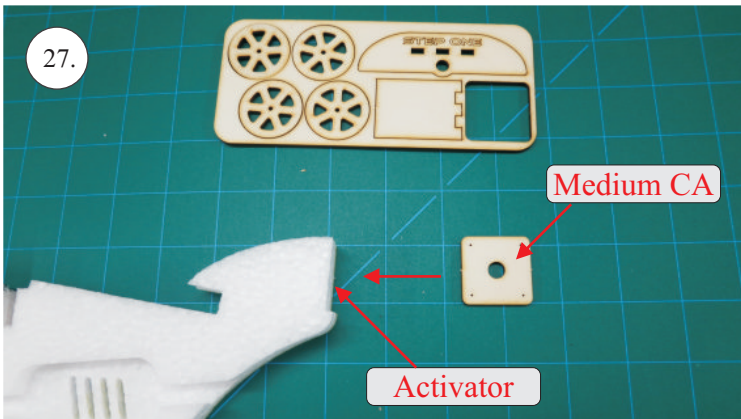
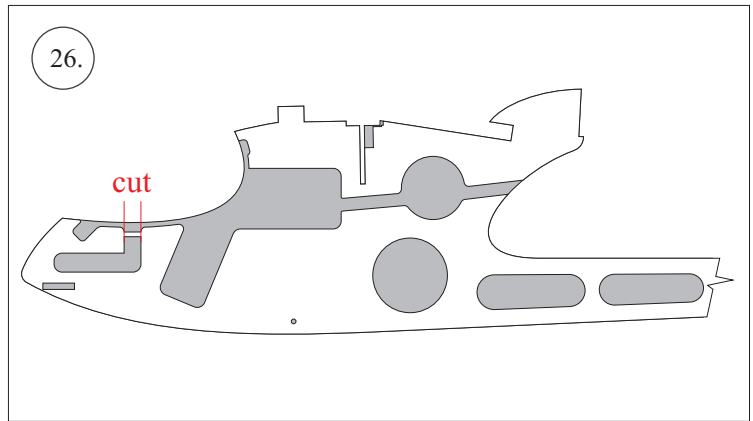
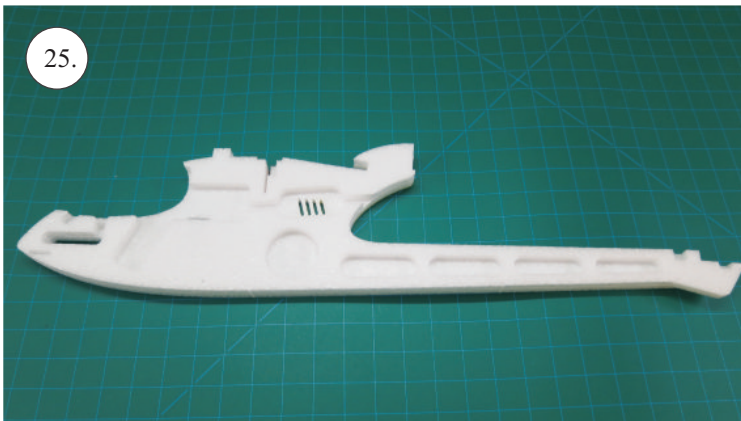
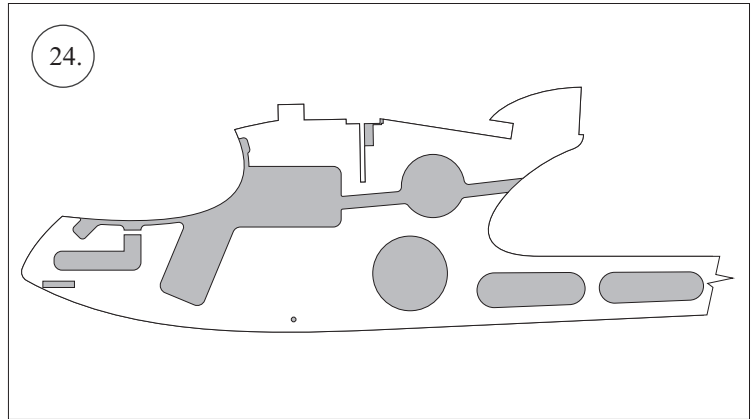
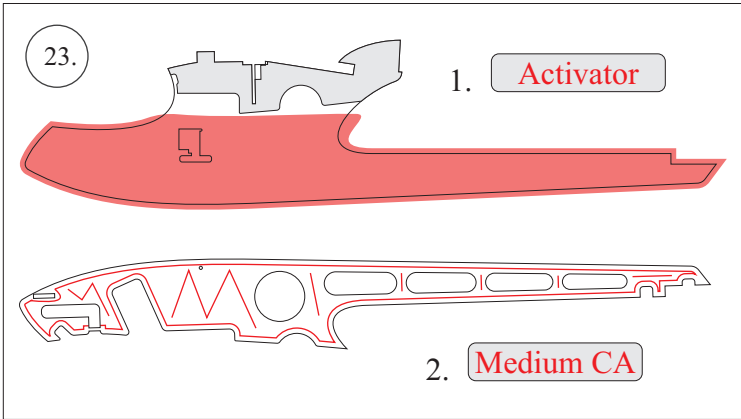
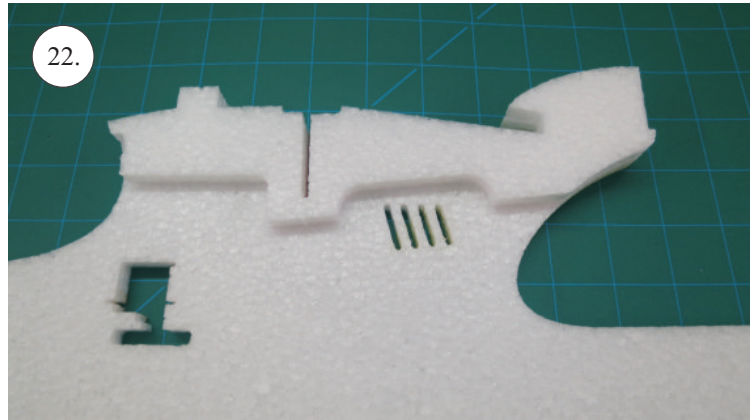
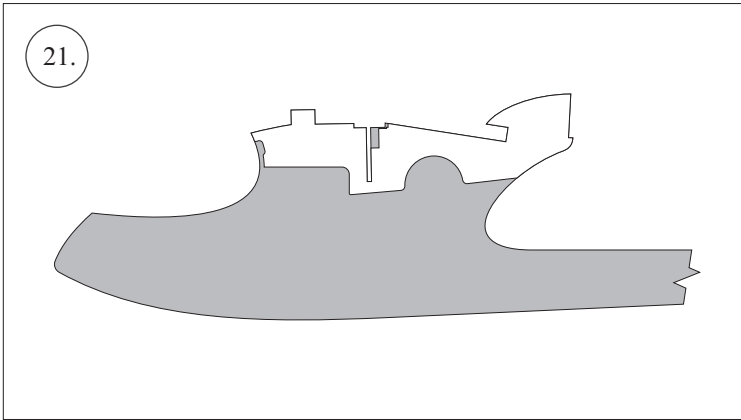

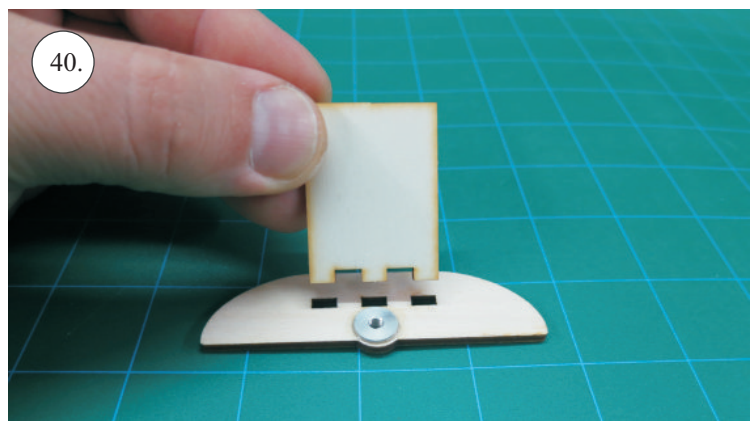
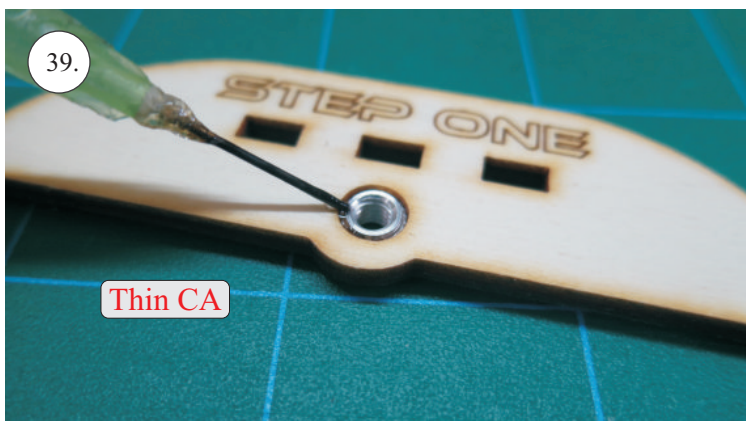
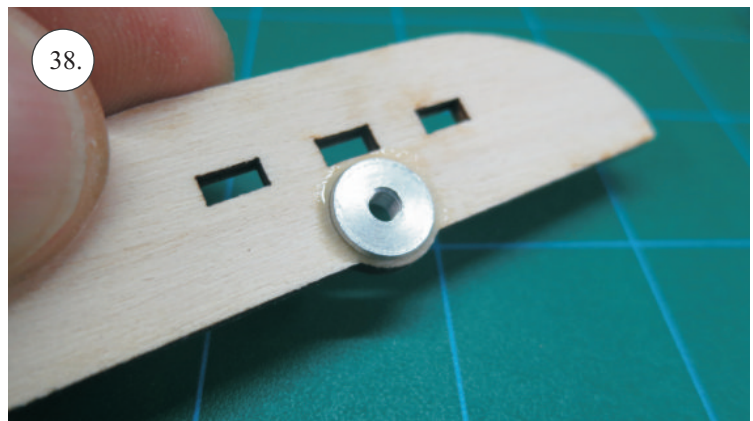
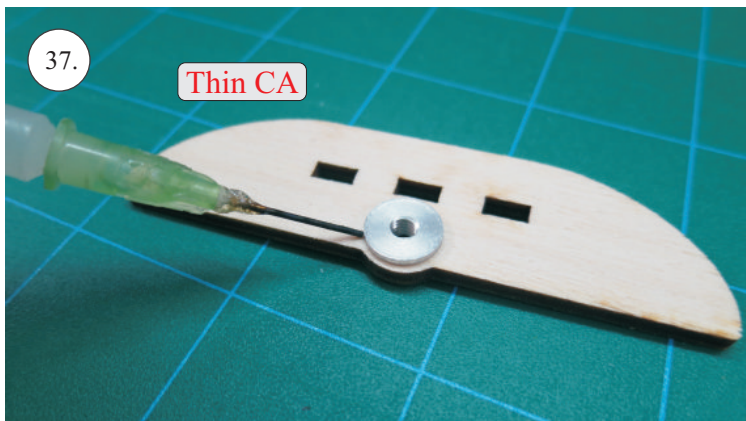
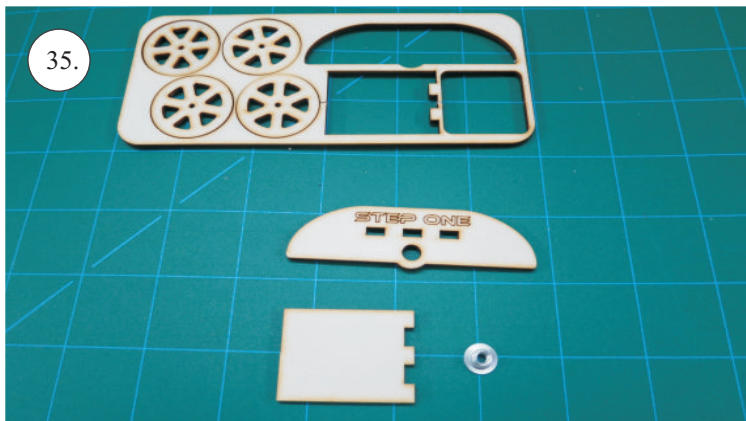
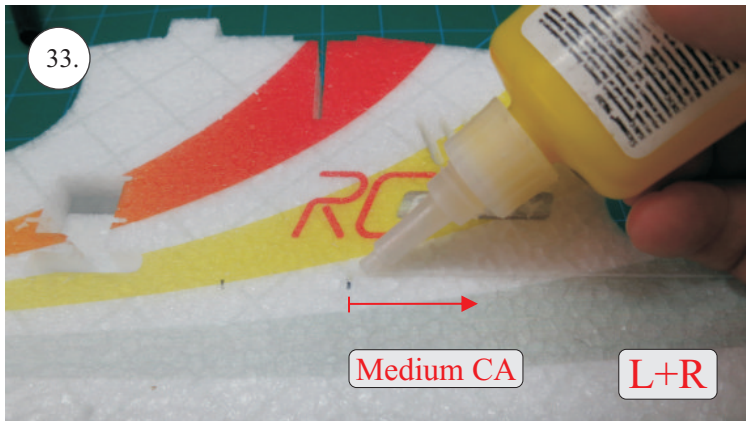
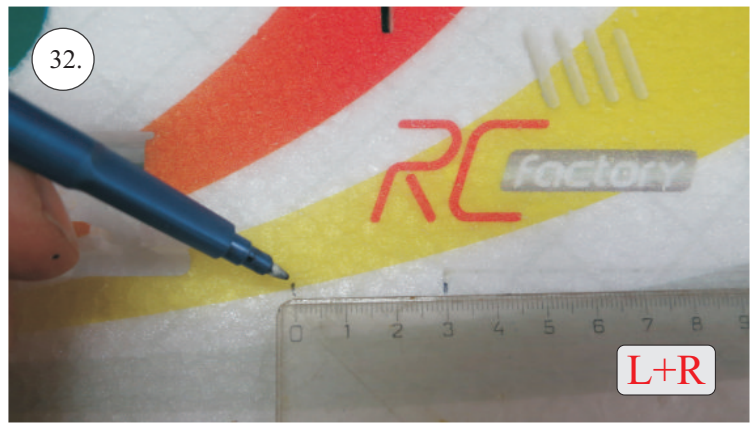
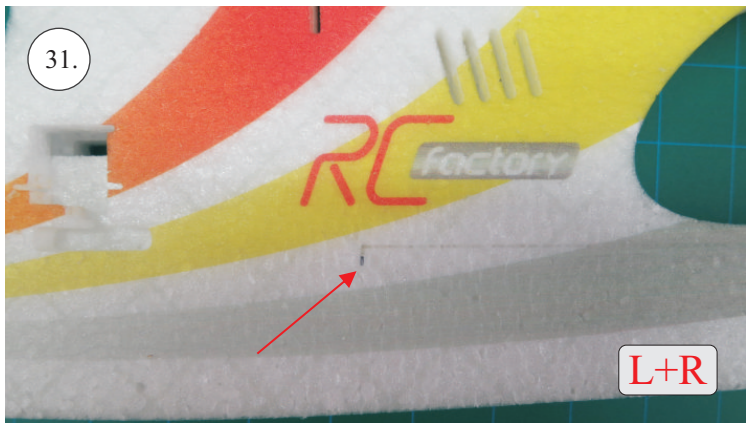

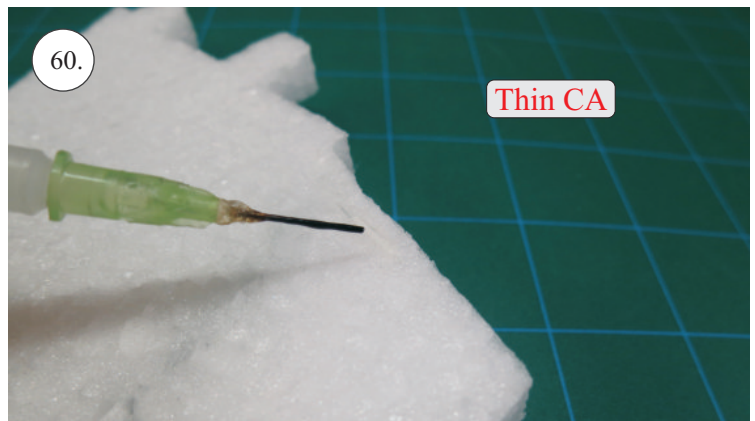
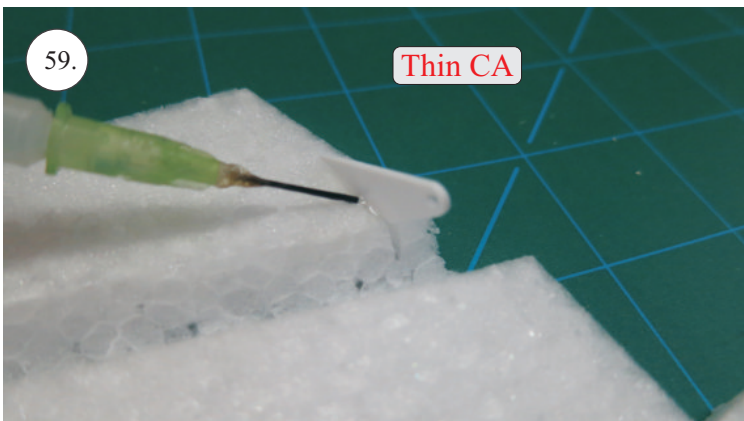
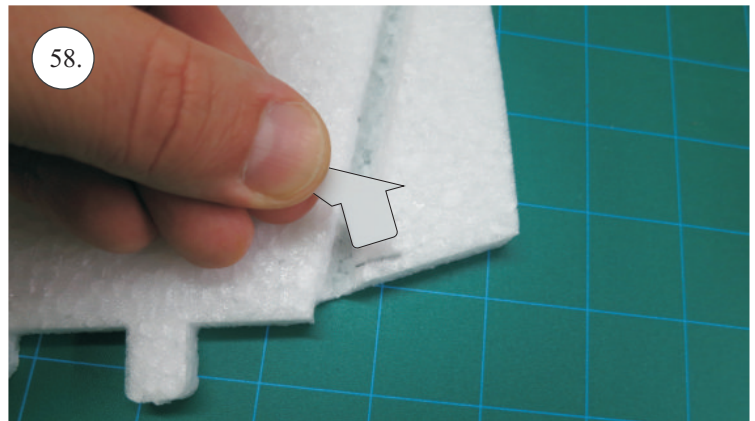
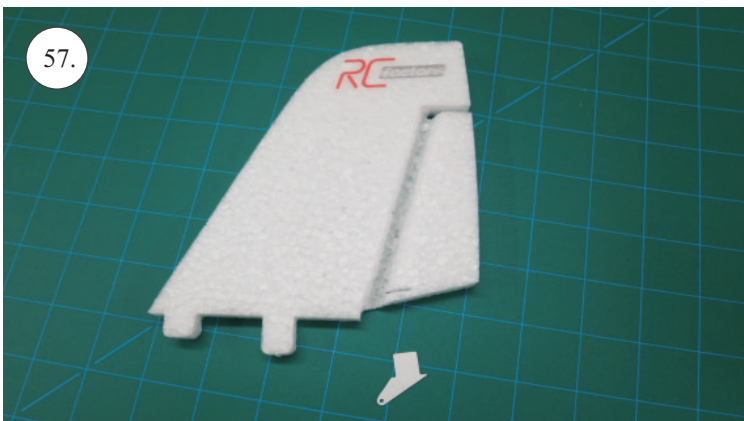
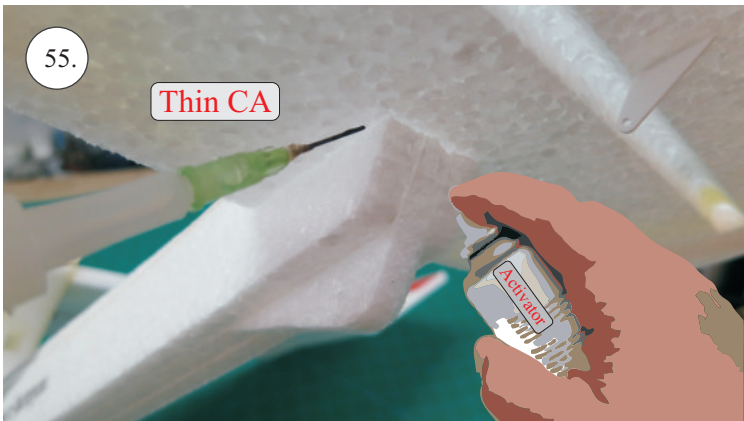
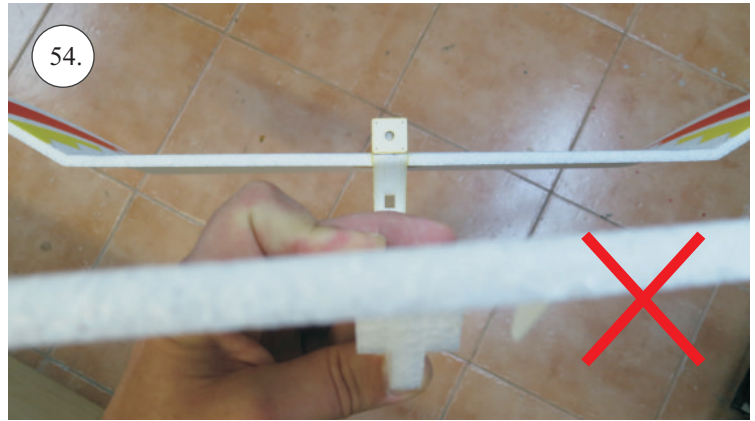
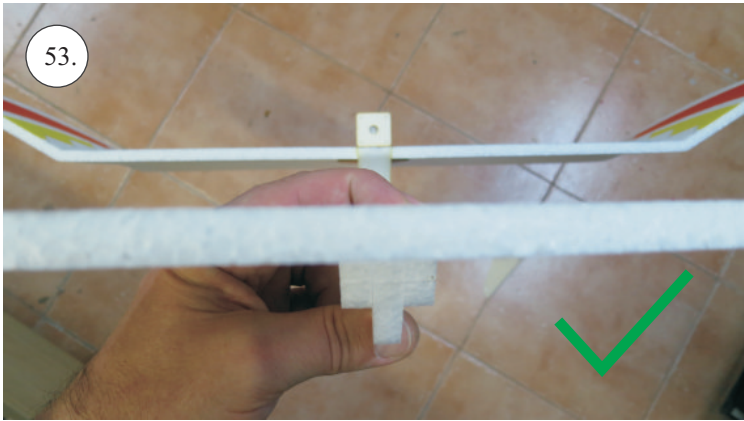
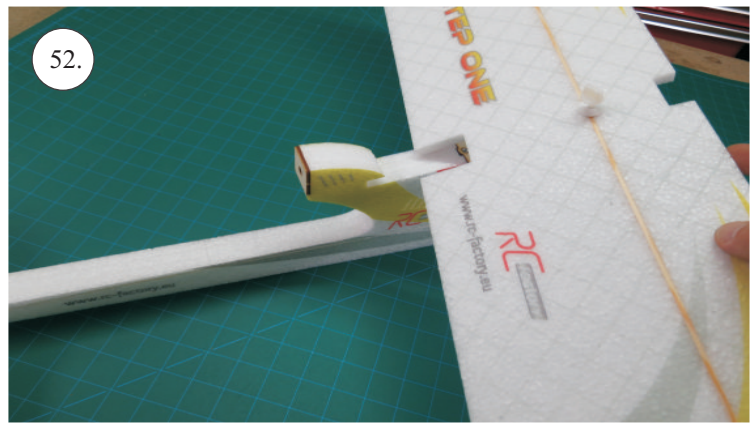
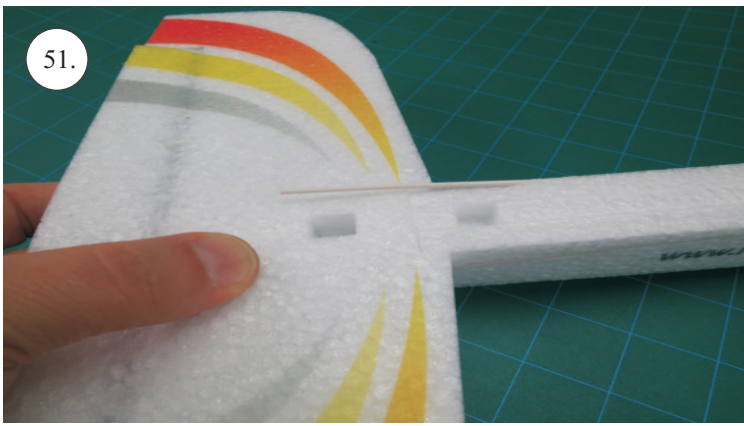

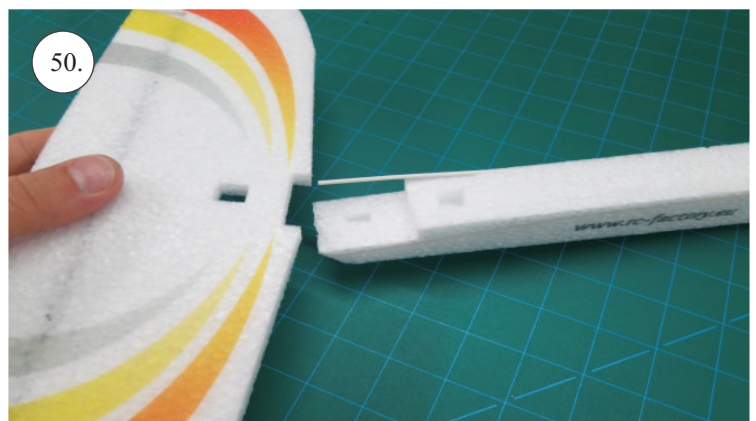
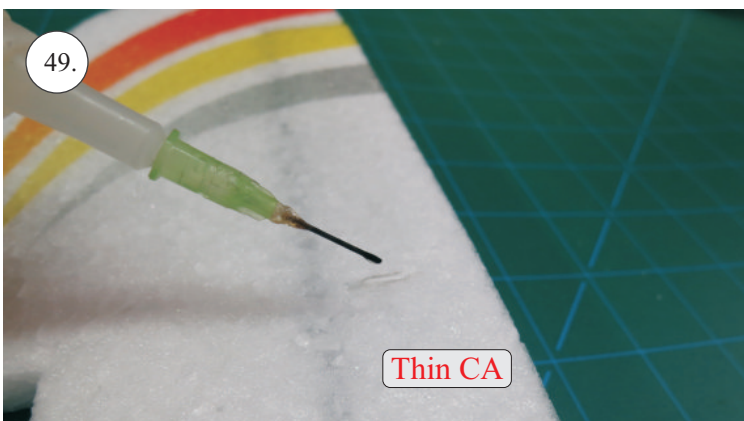
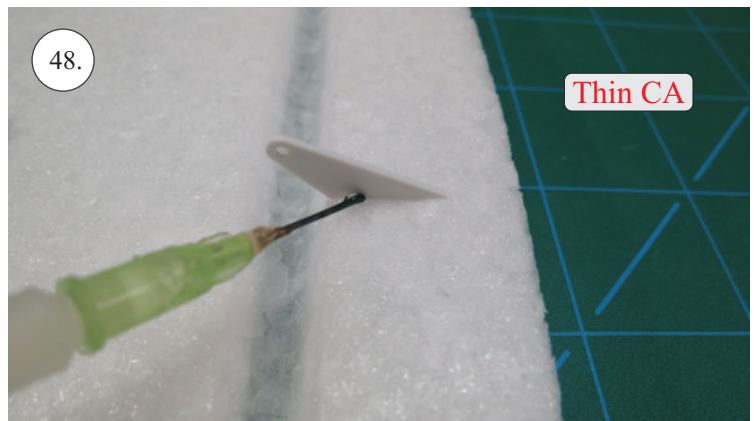
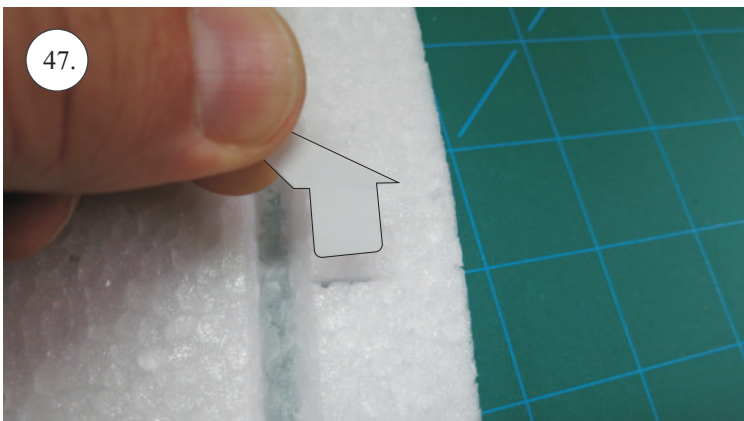
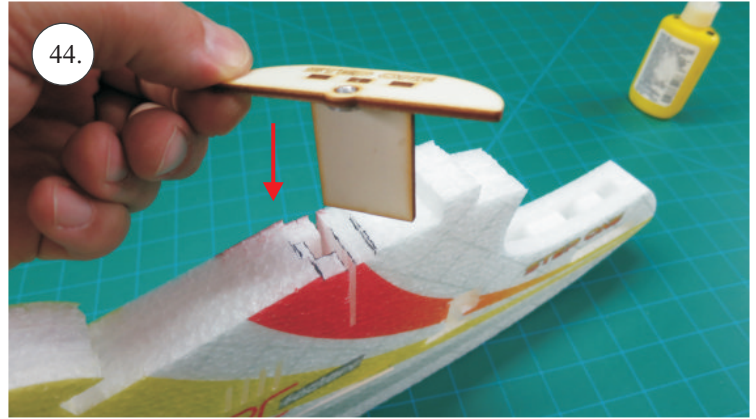
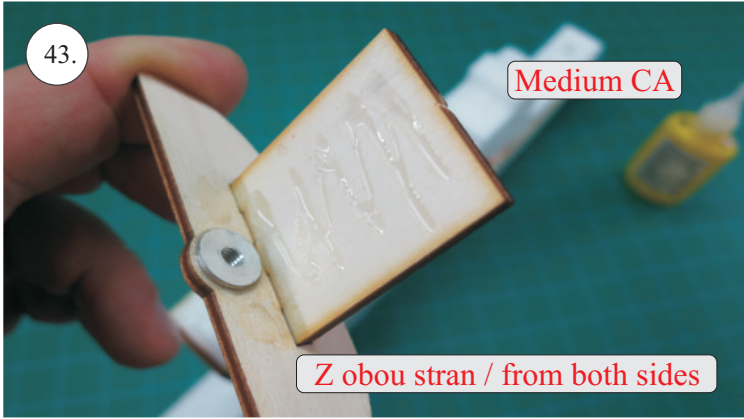
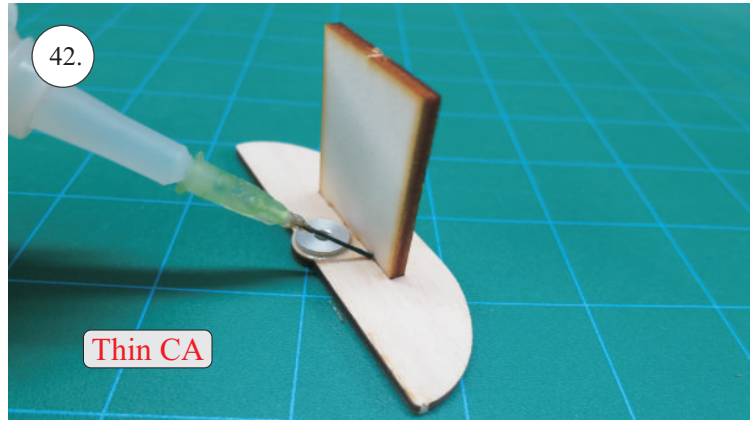
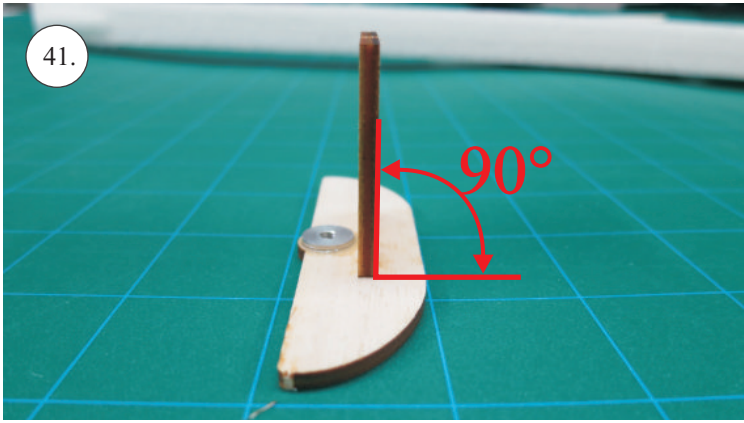

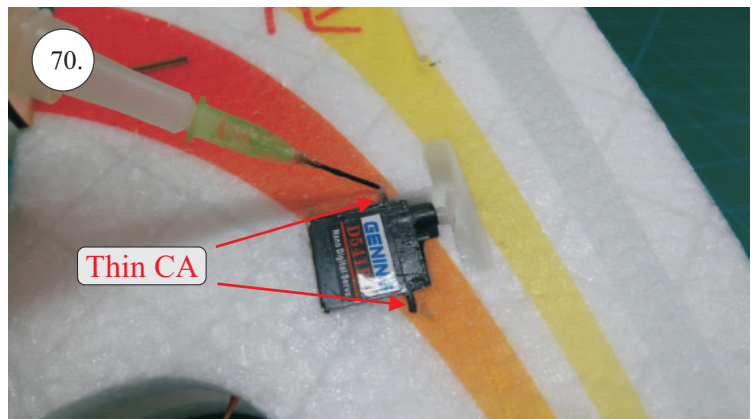
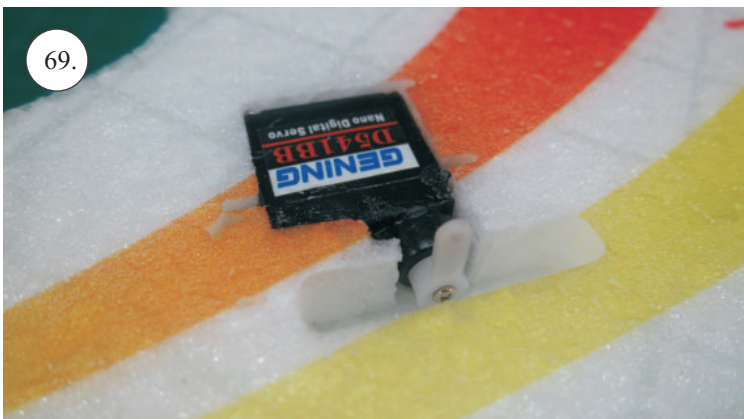
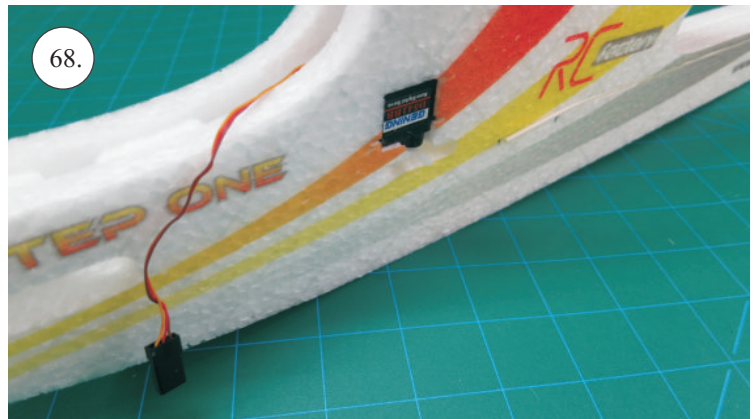
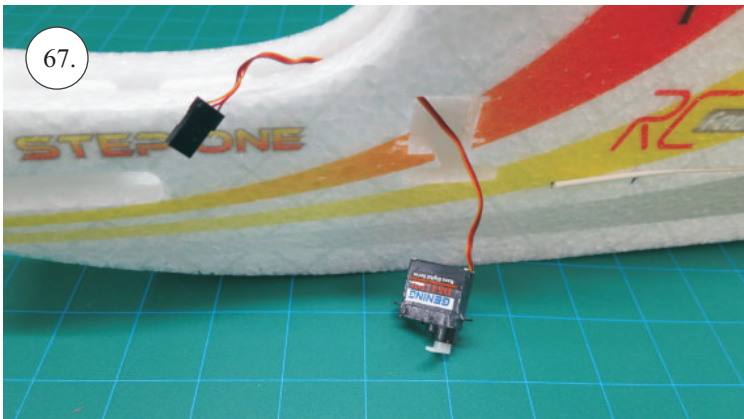
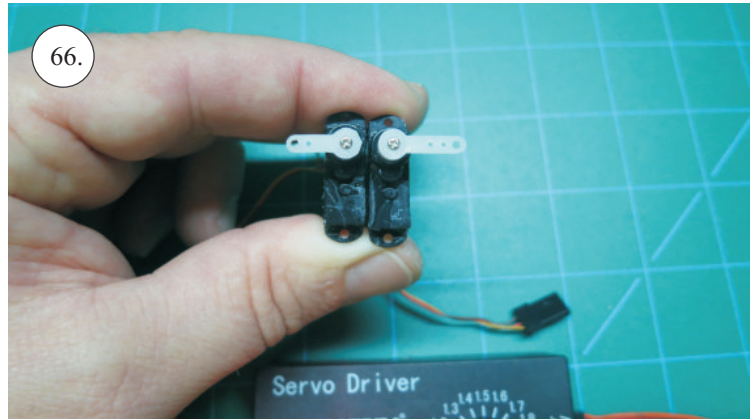
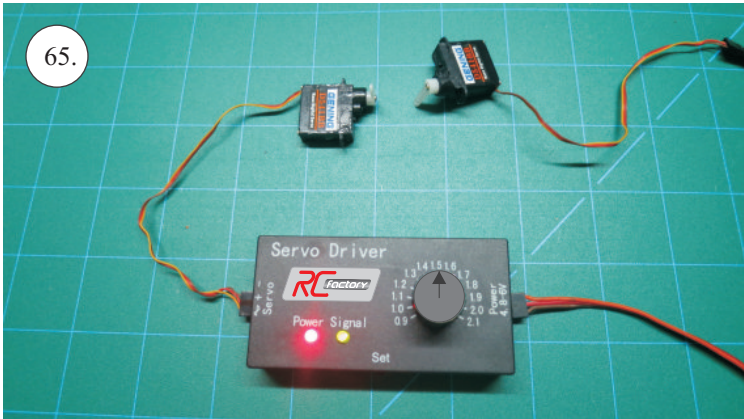
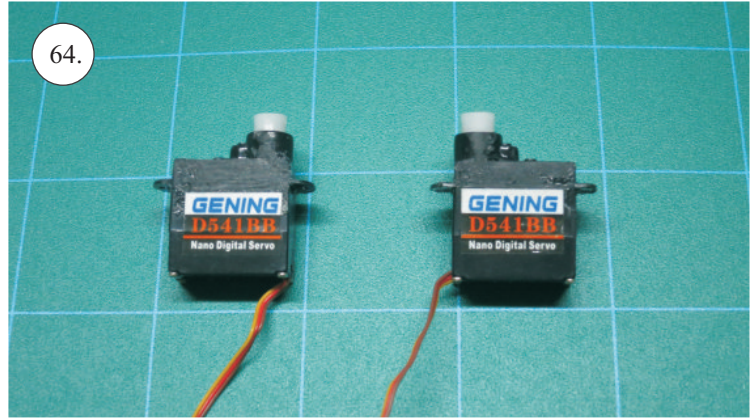
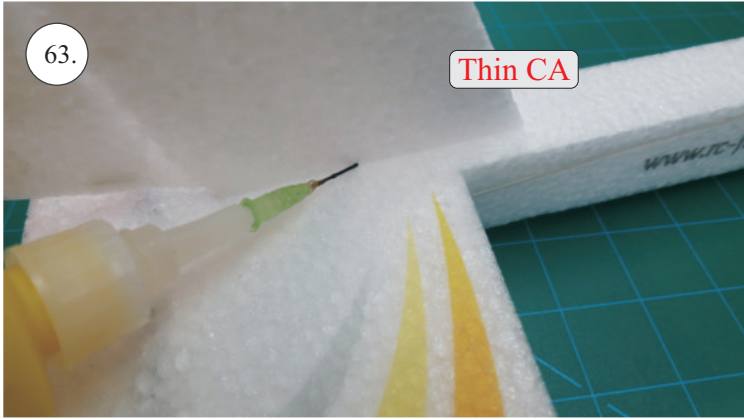
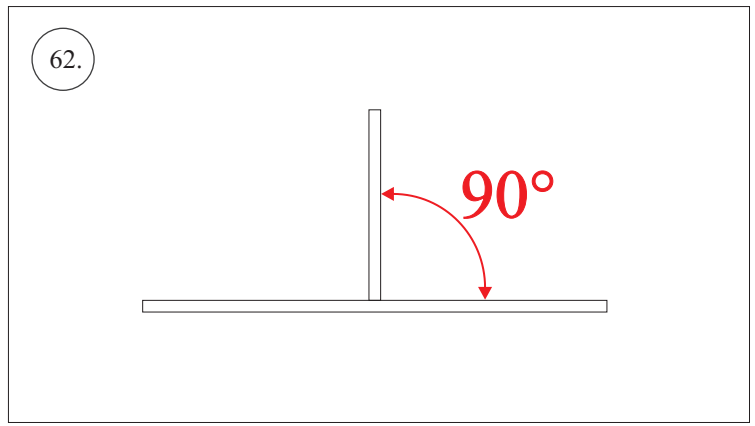
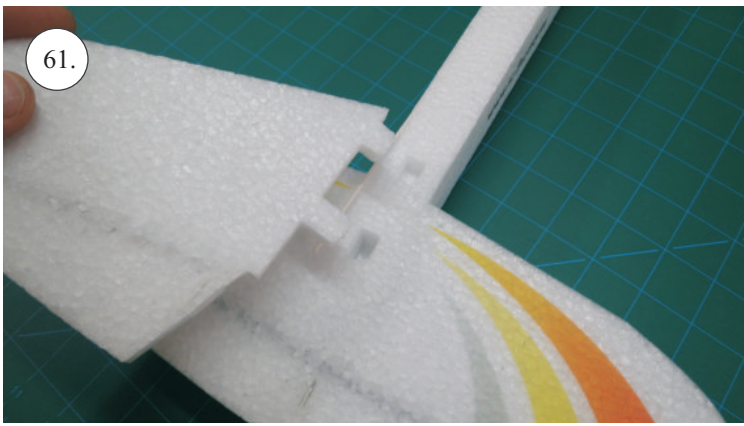



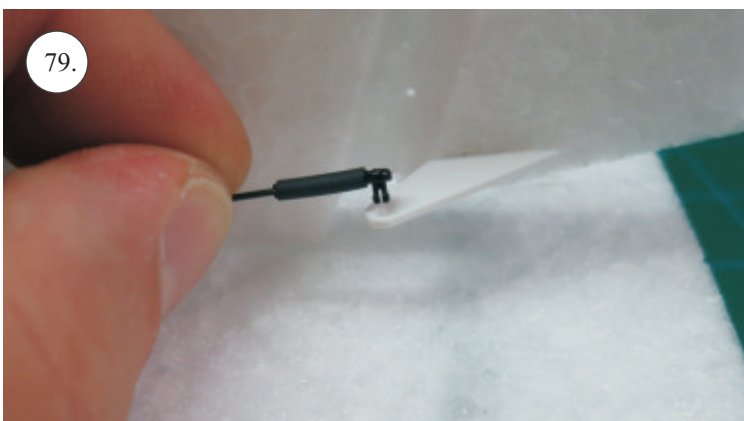
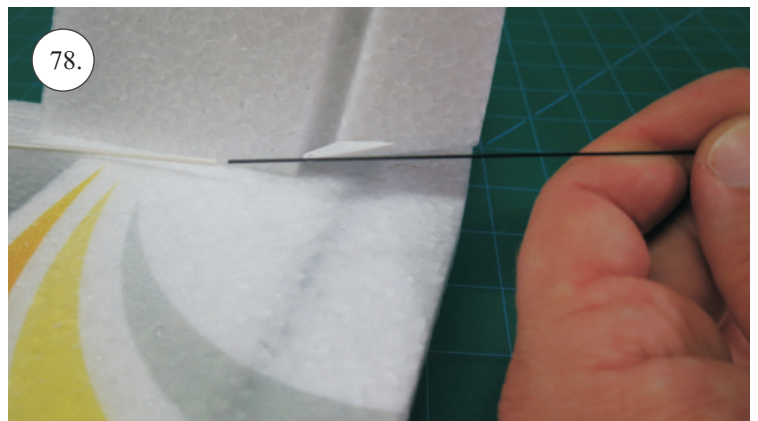
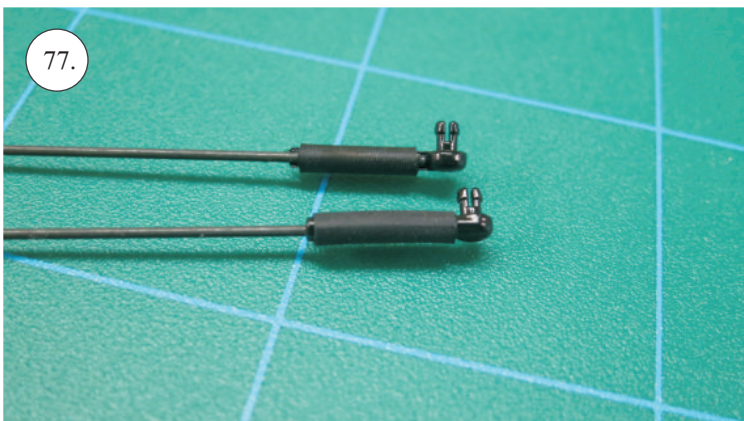
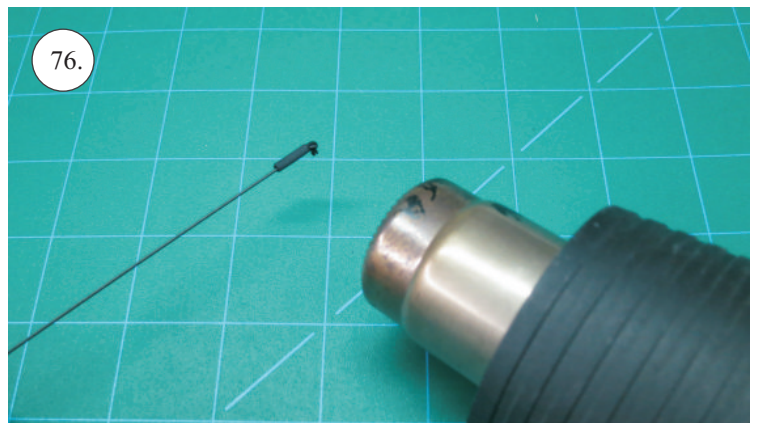
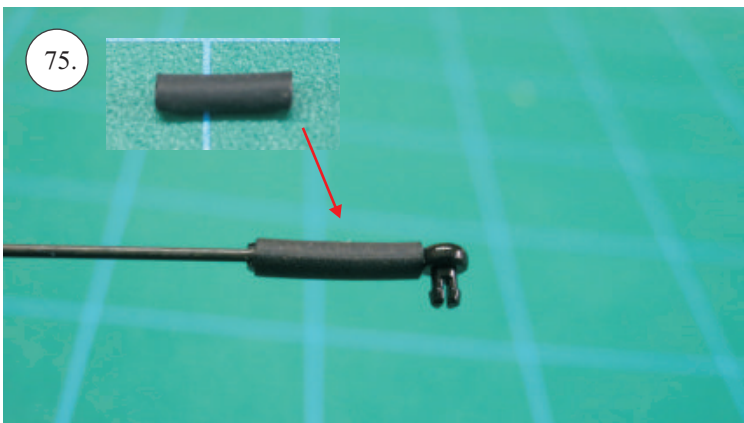
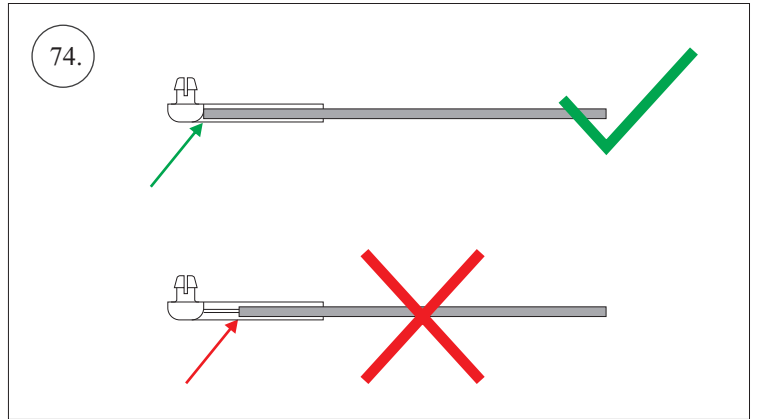
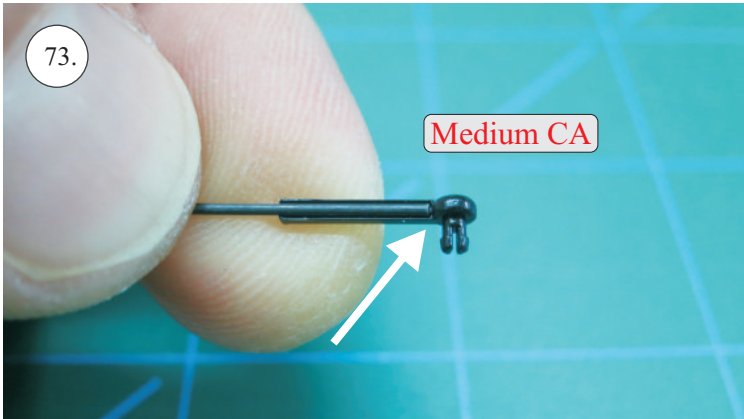
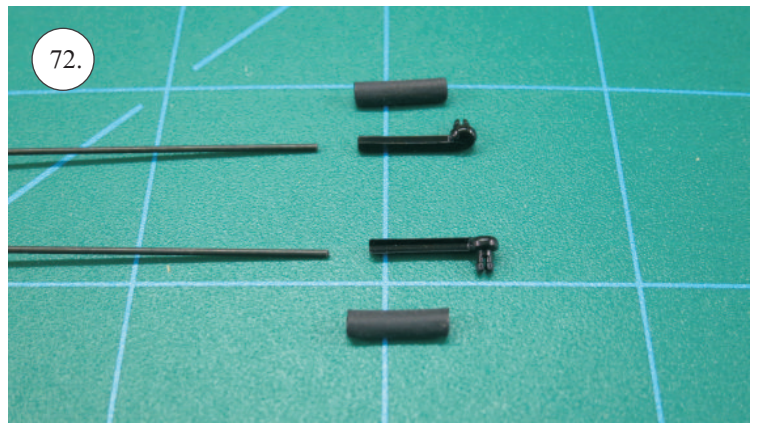
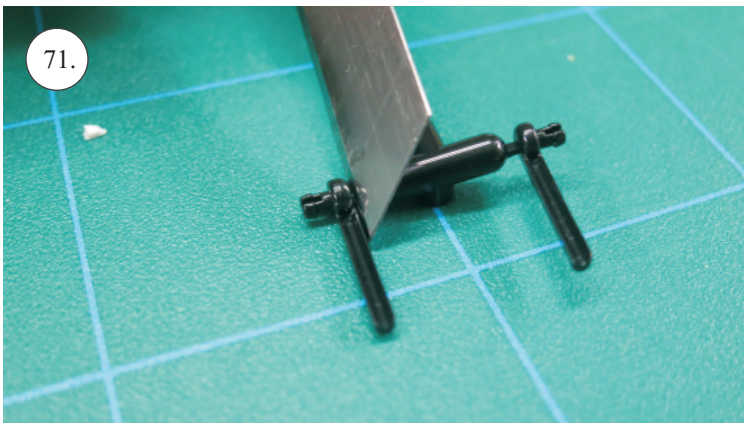

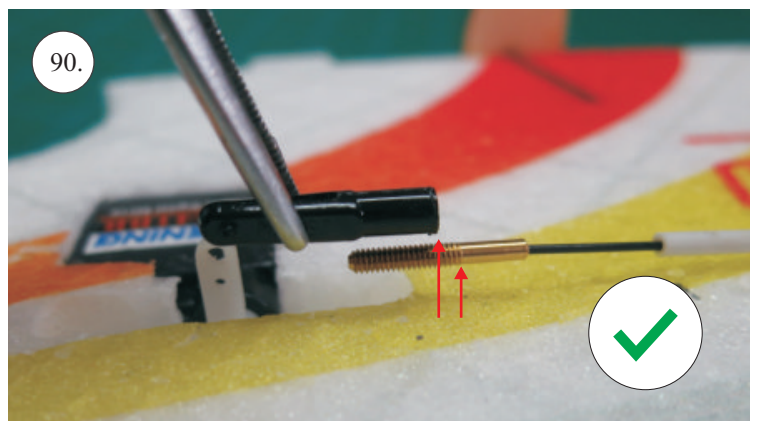
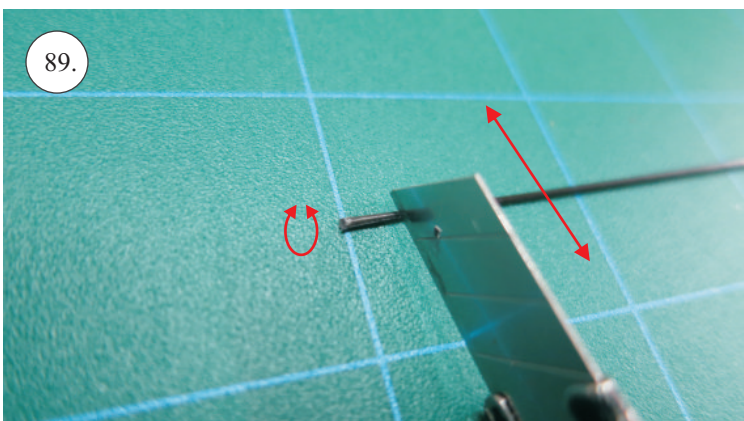
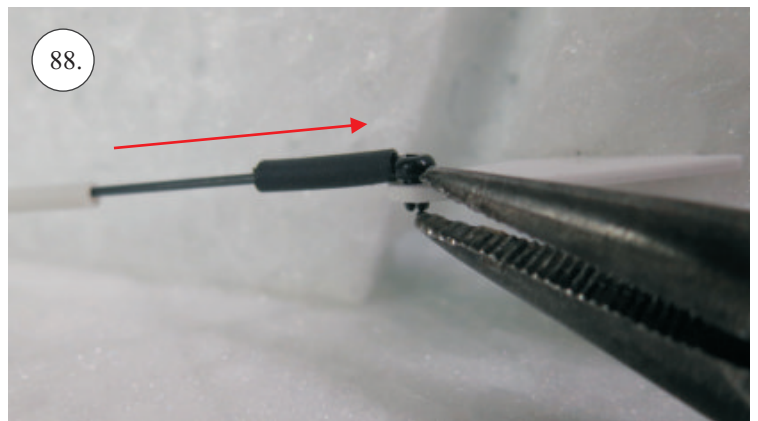
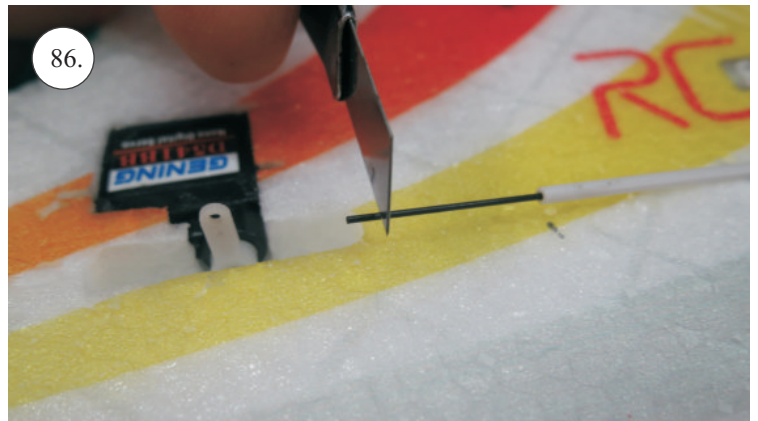
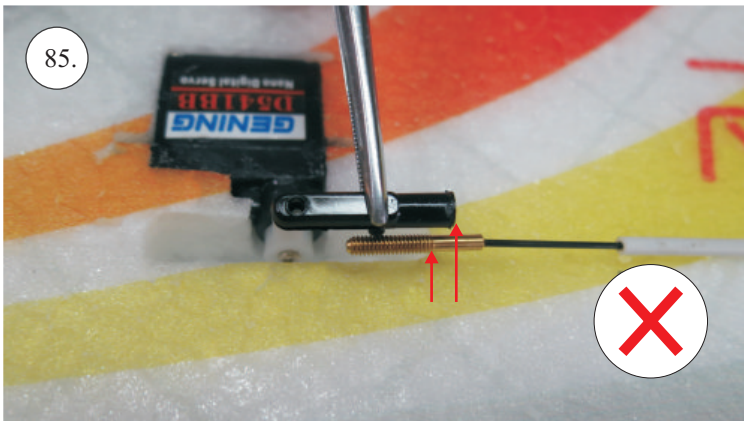
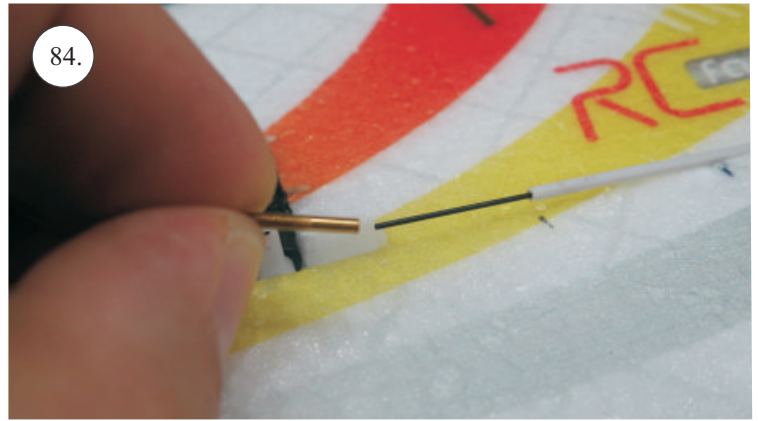
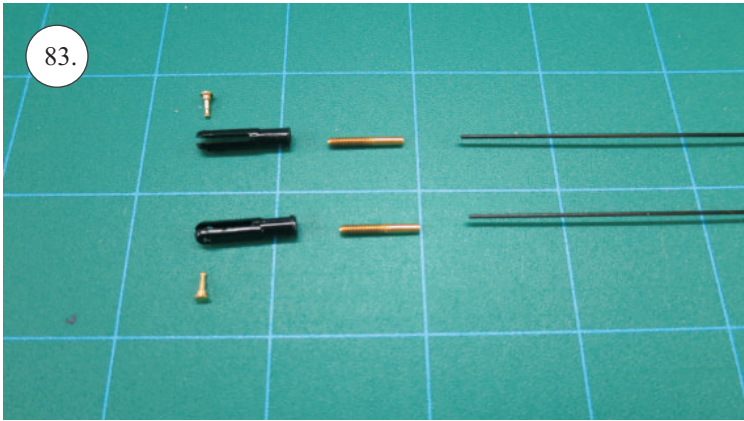
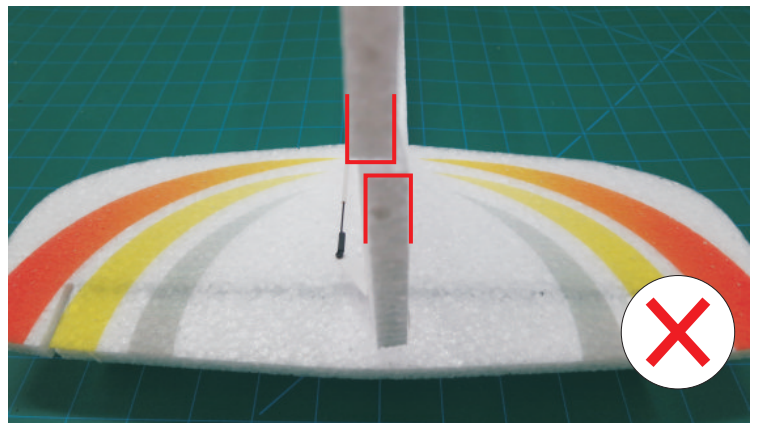
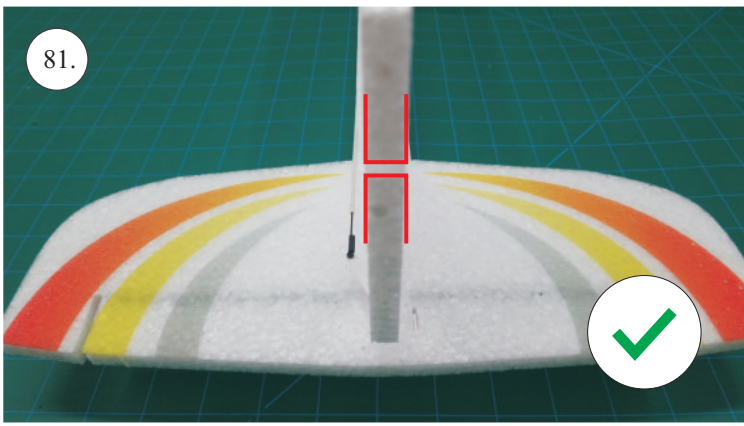

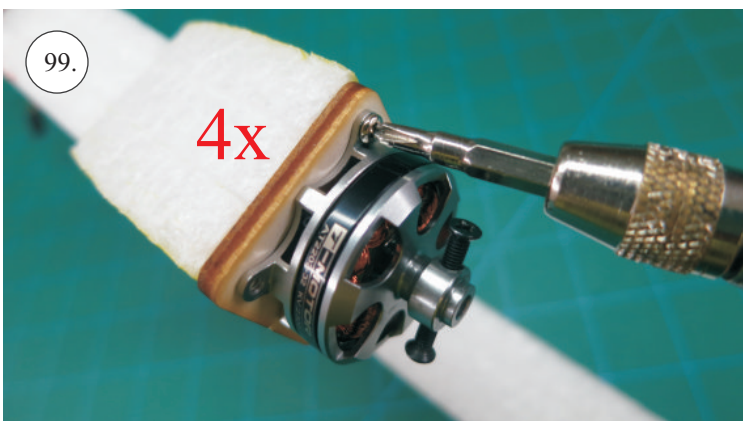
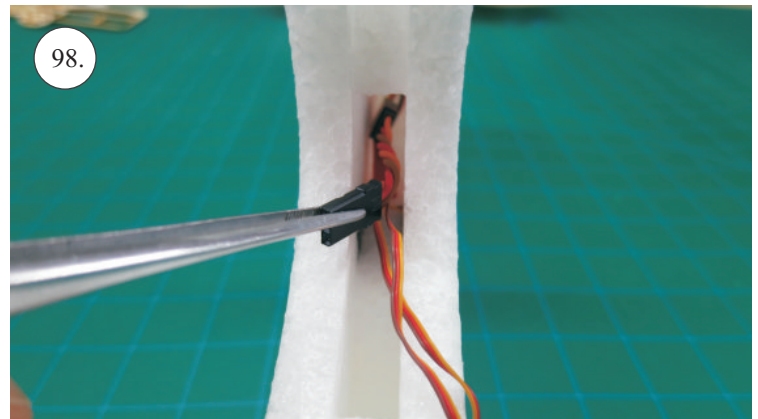
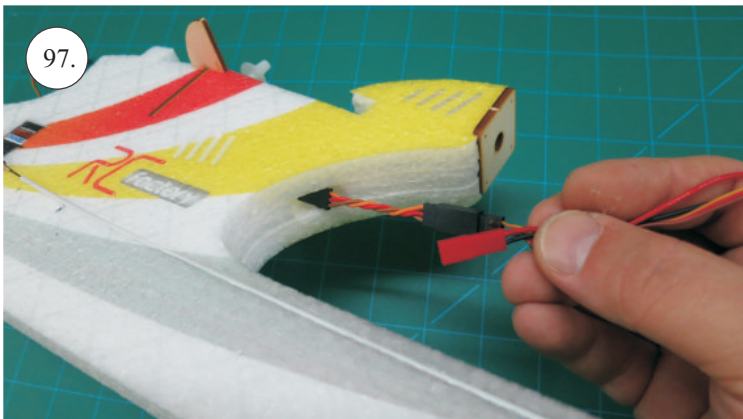
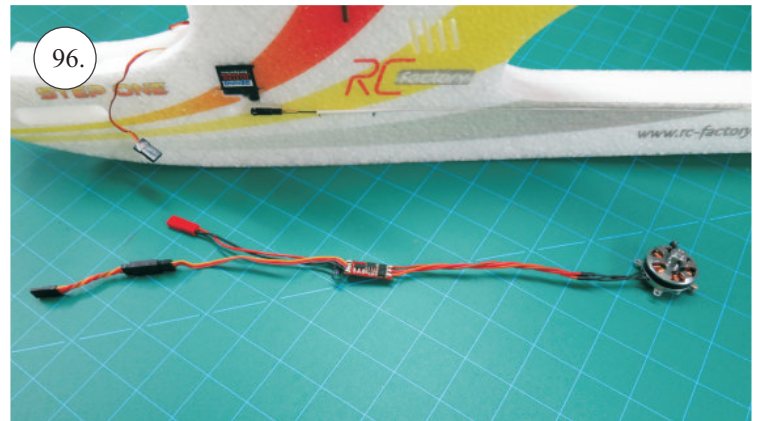
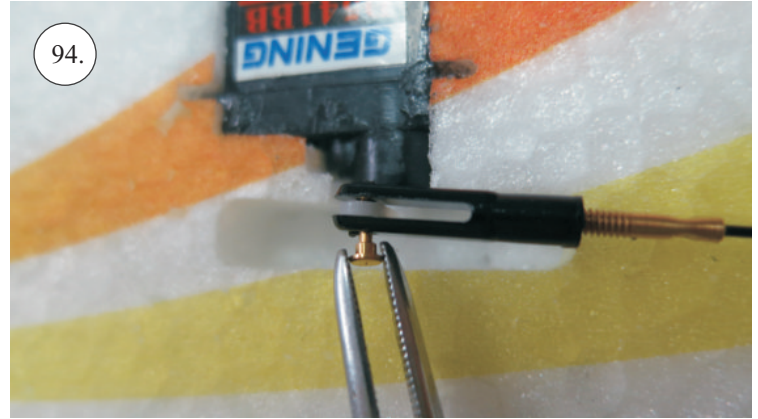
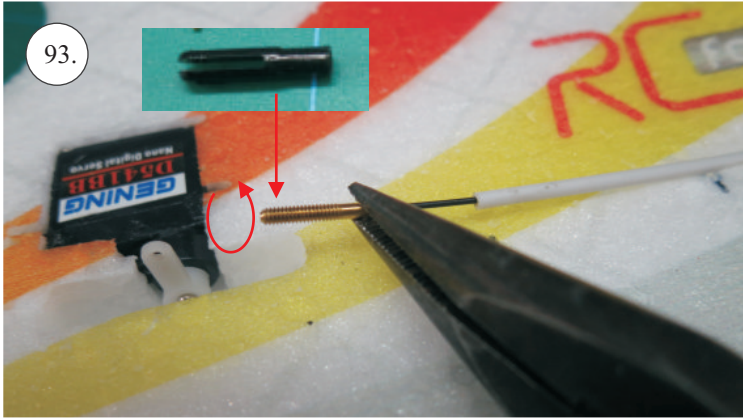
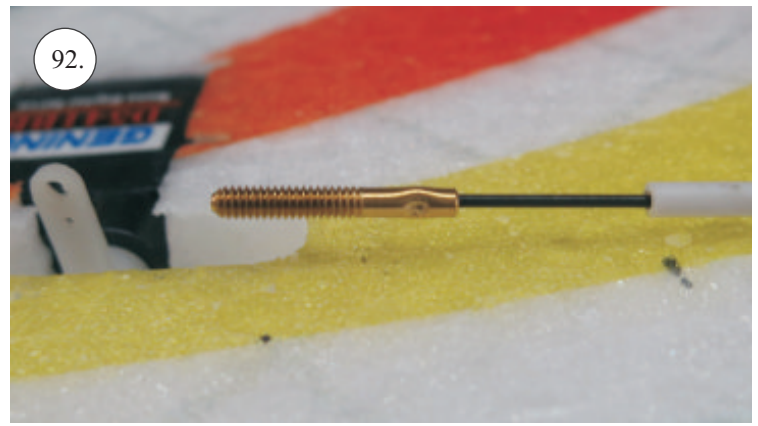
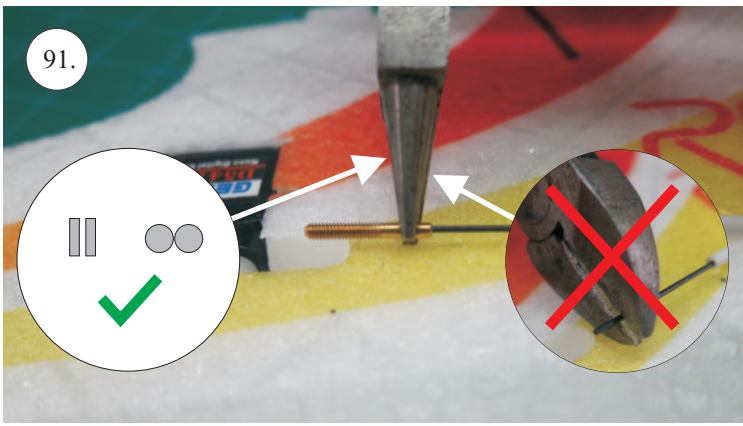

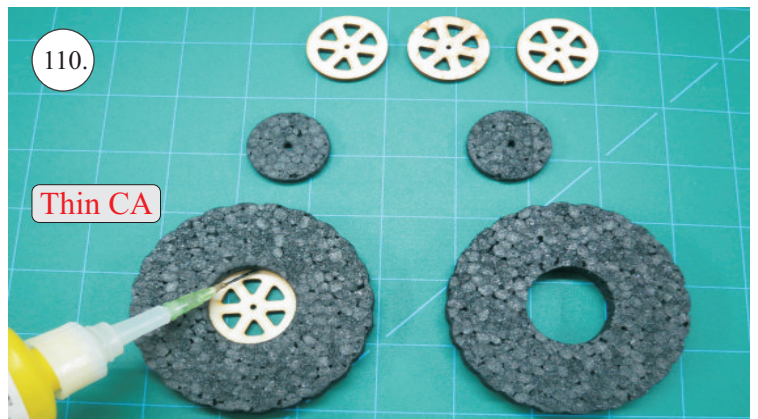
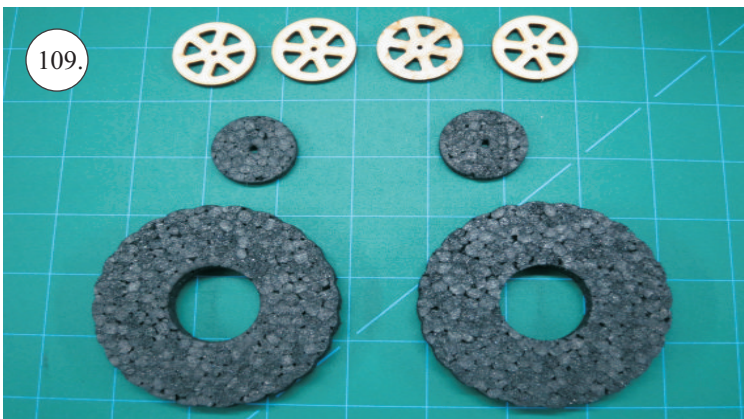
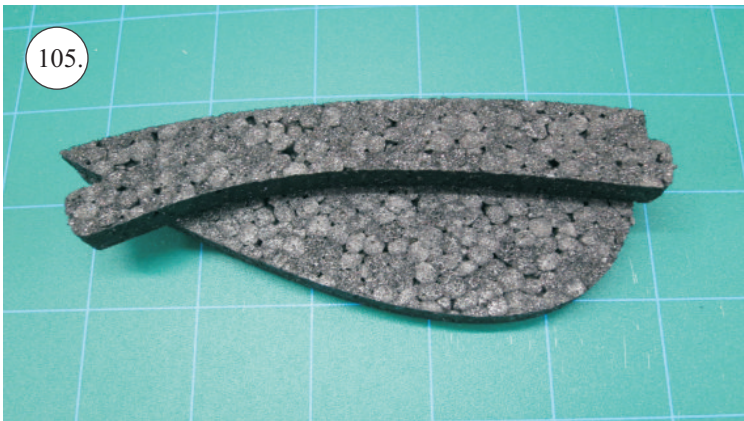
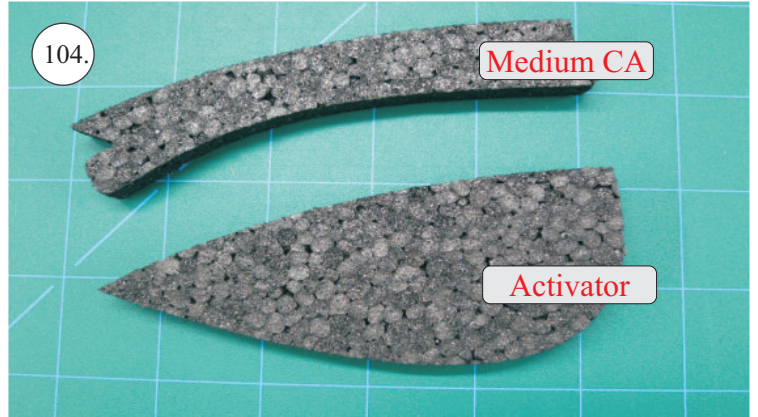
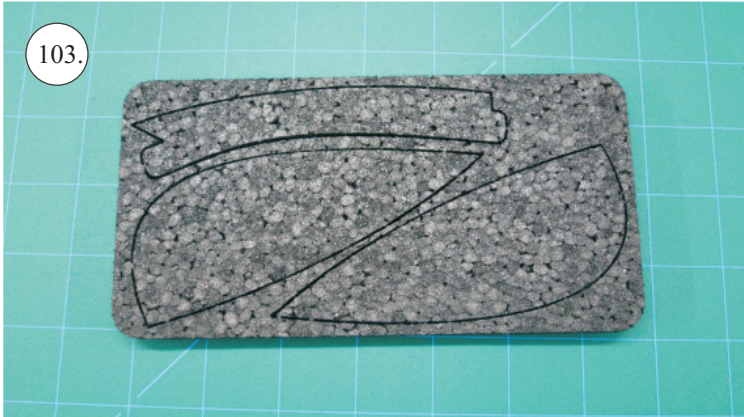
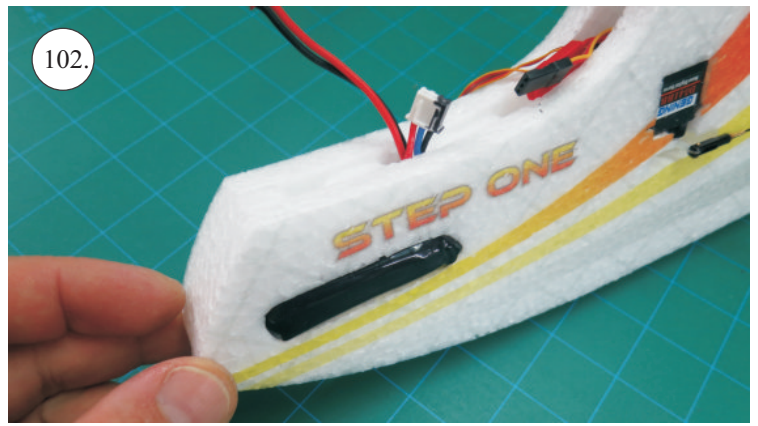
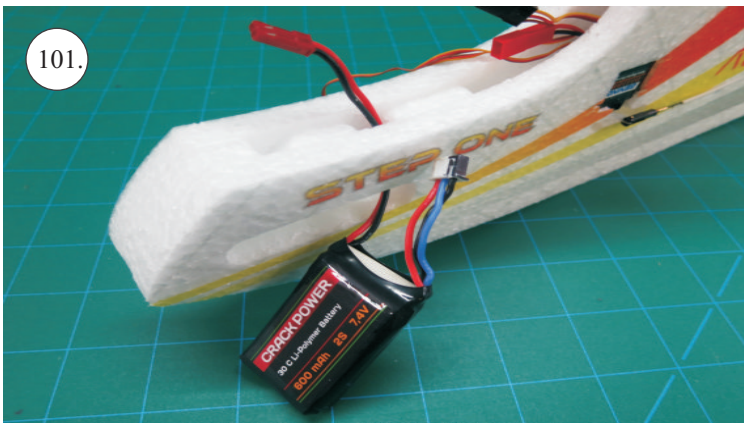

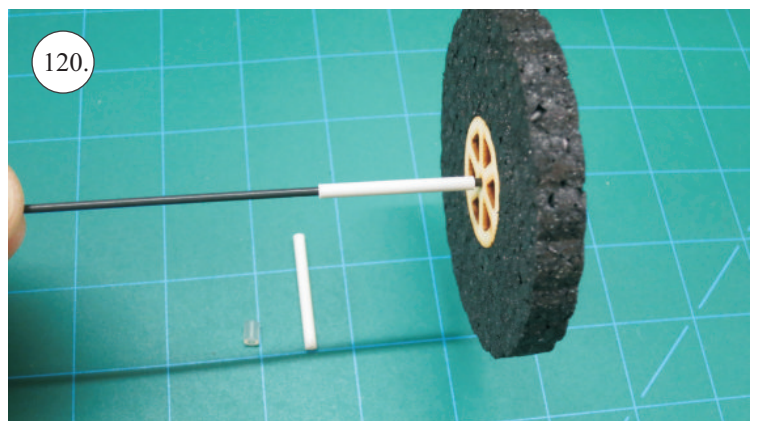
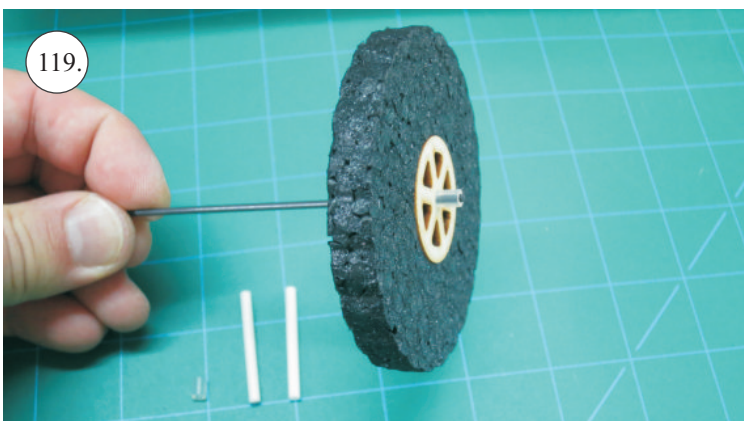
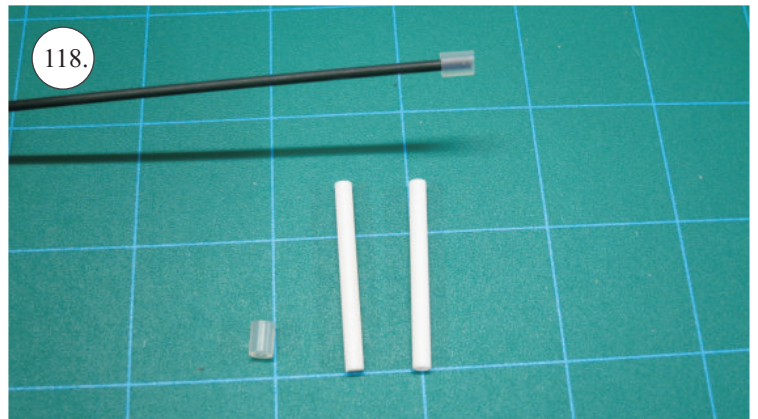
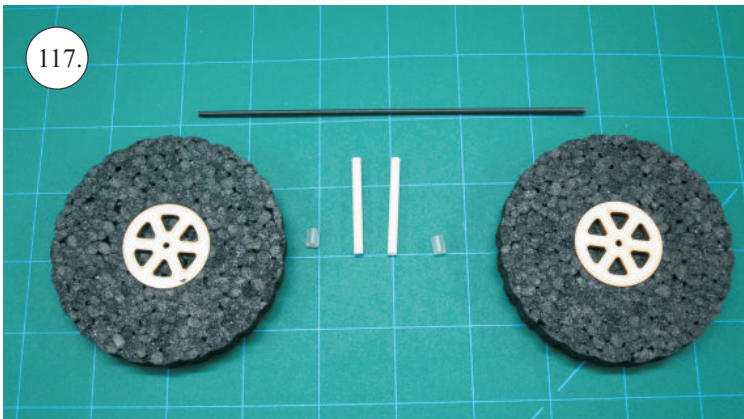
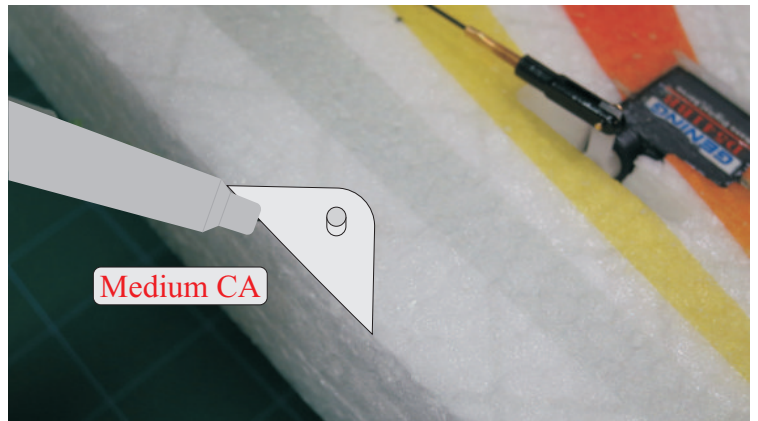
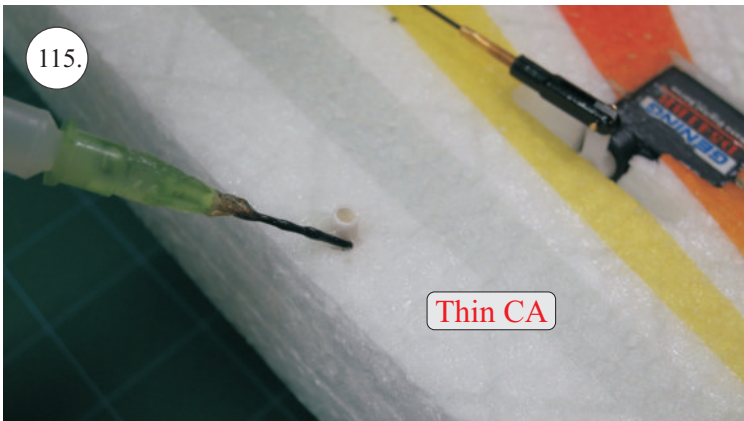
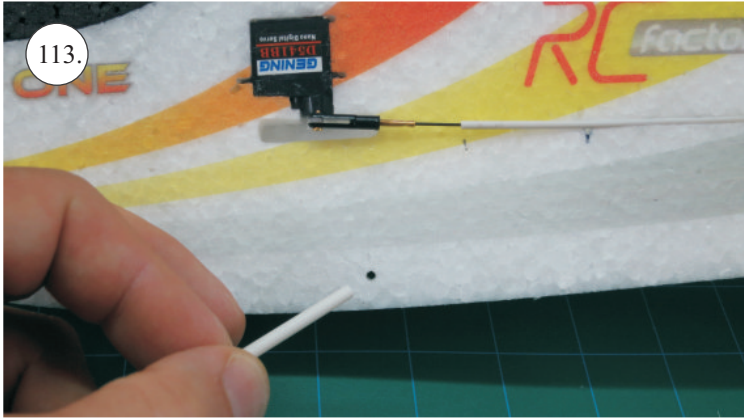
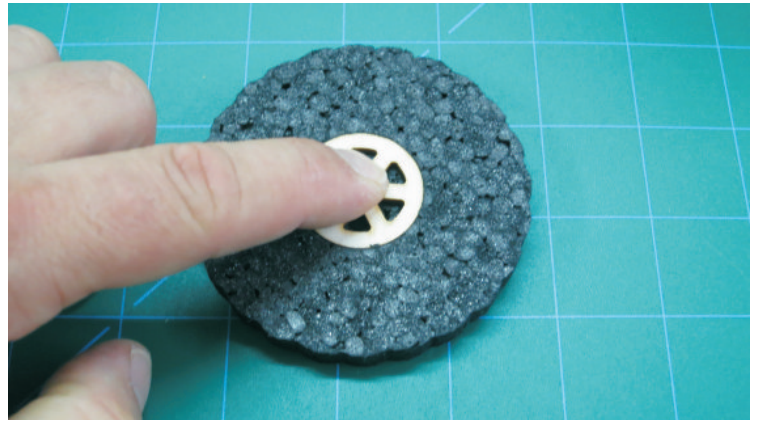

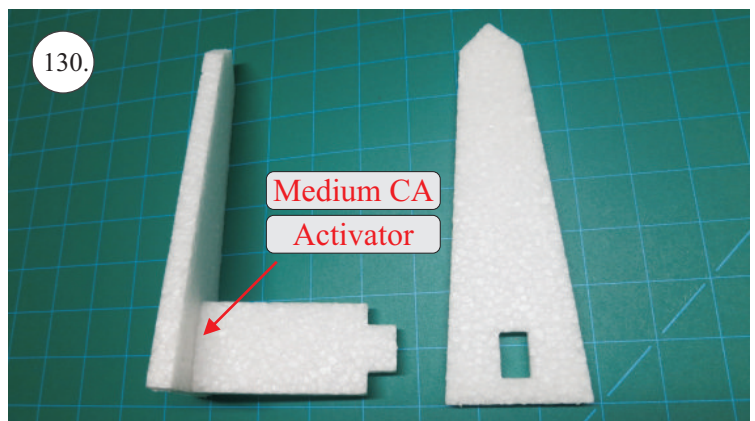
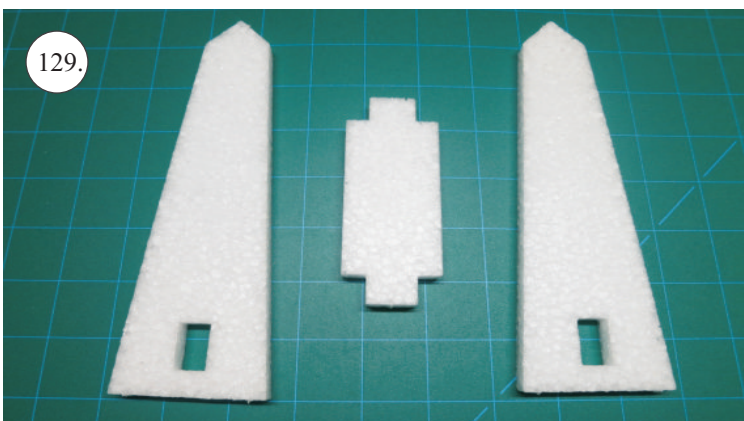
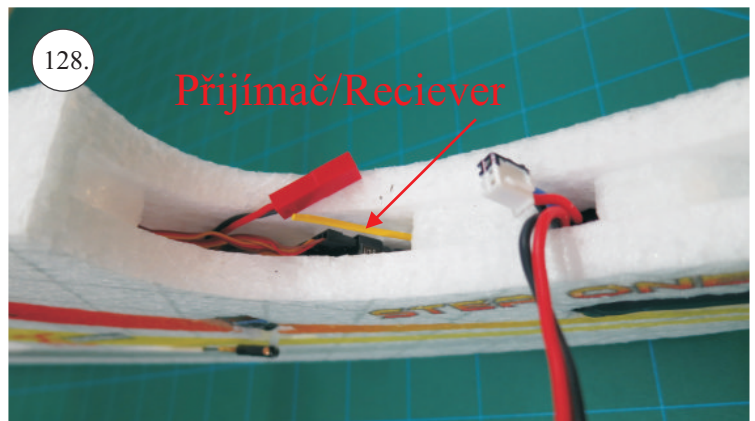
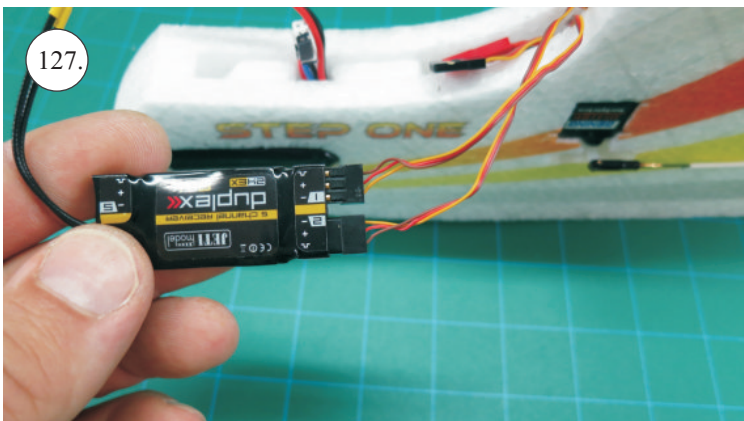
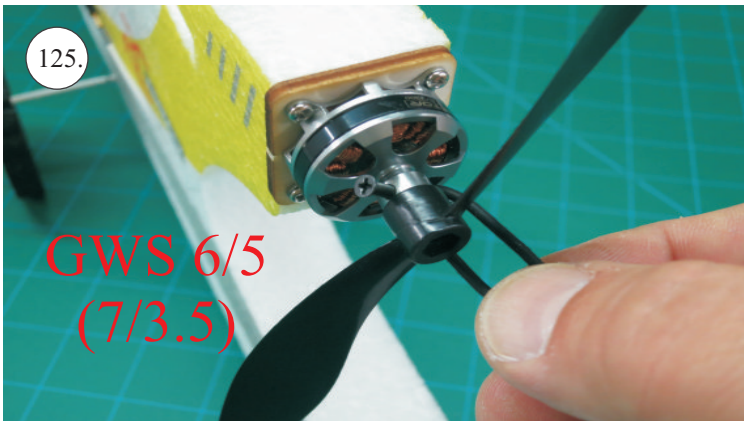
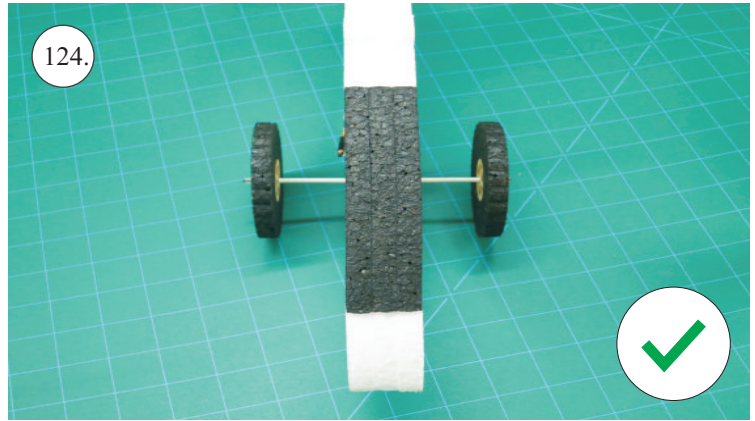
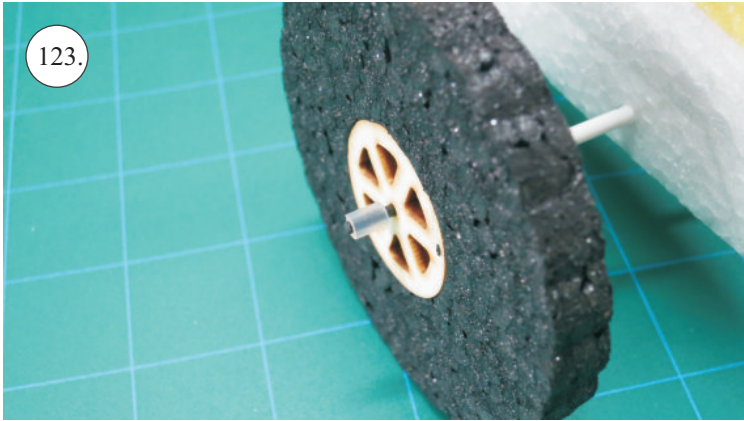
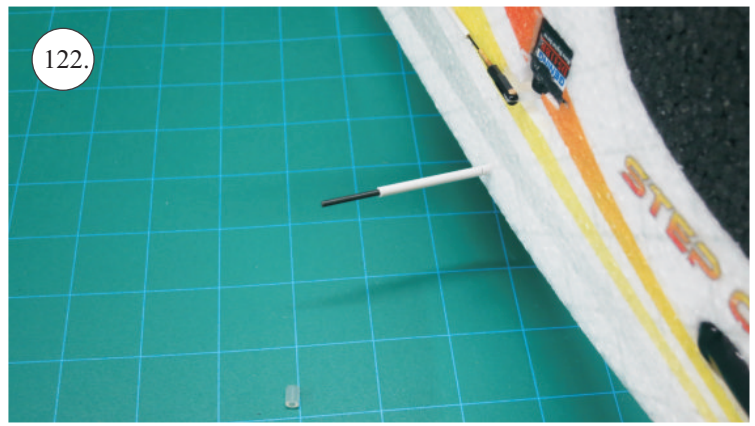
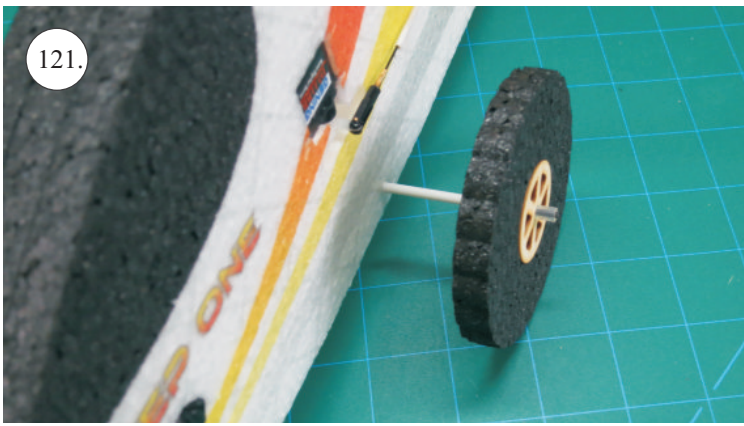

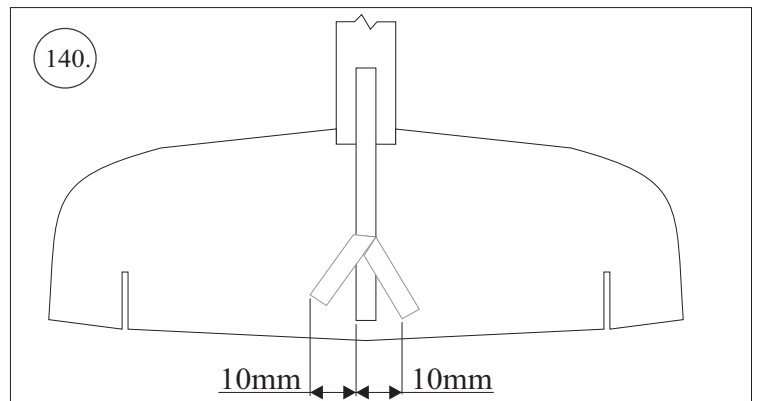
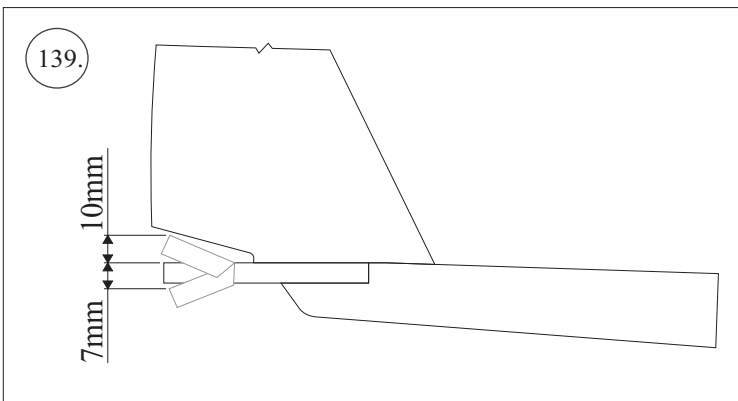
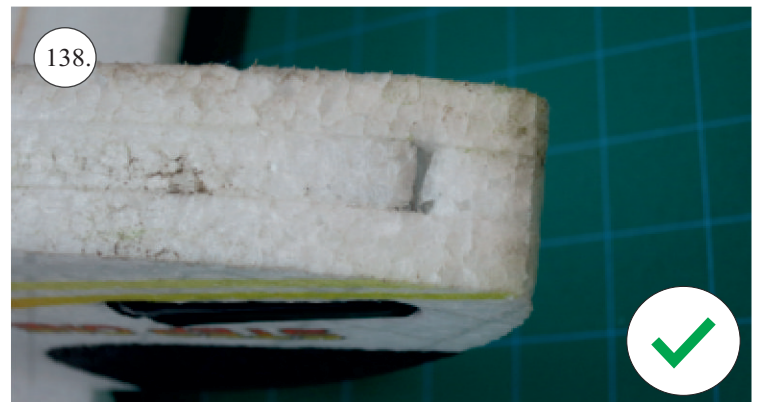
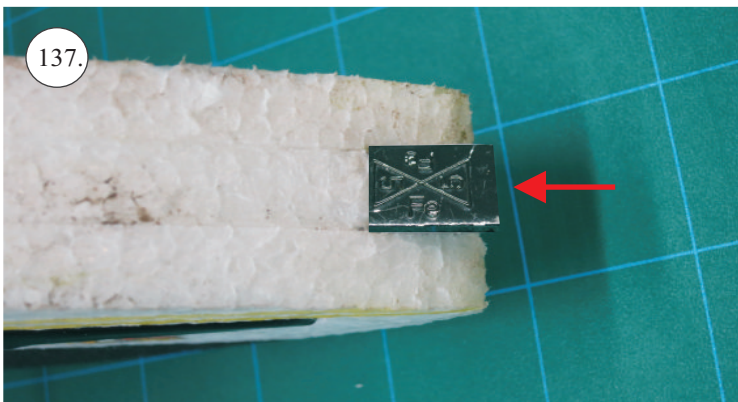
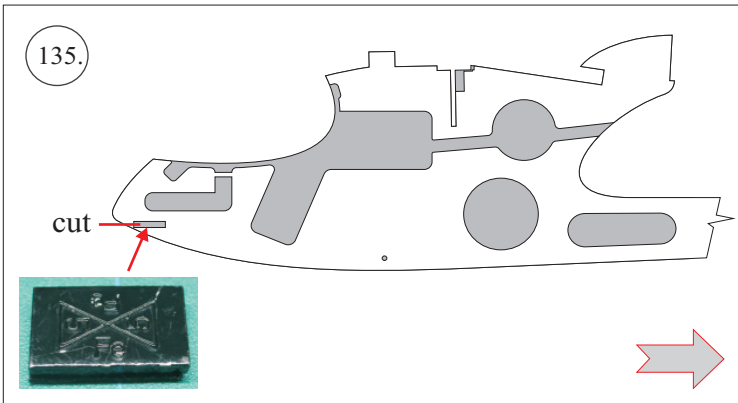
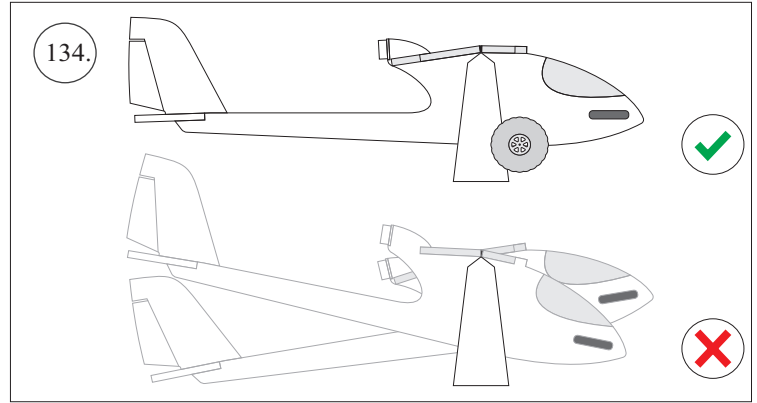
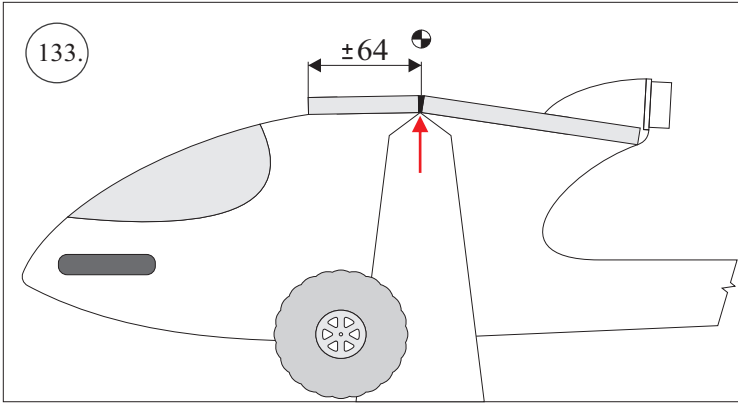
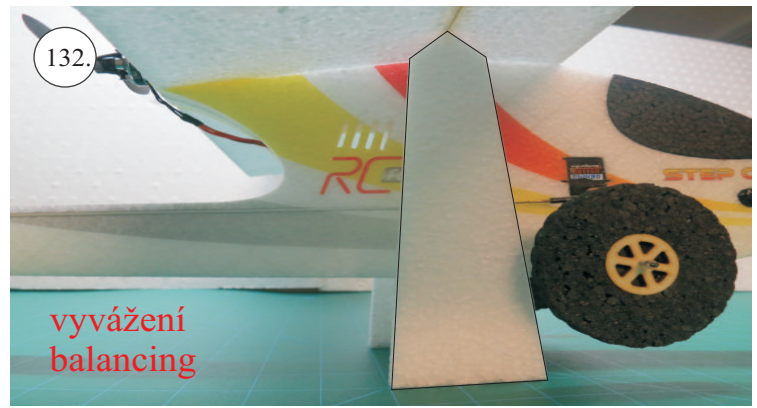
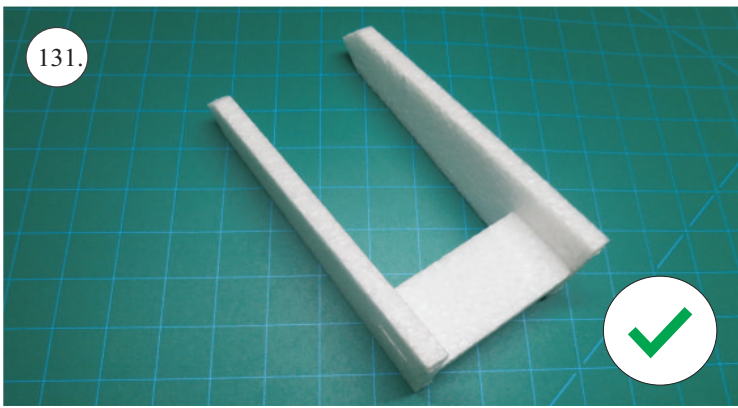

We wish you many happy flying hours with the Step One.  
Your RC Factory team.